











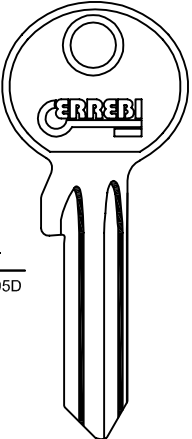
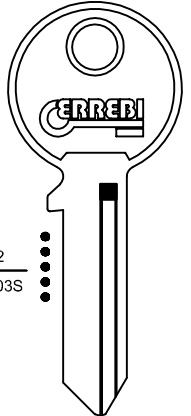
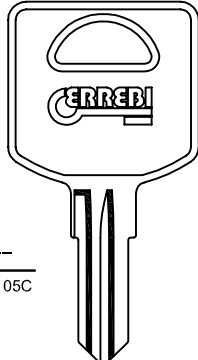

Errebi - News 01-2021

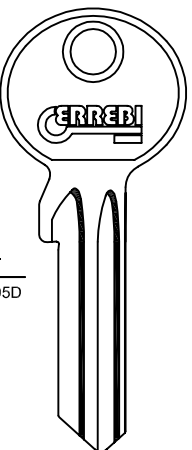
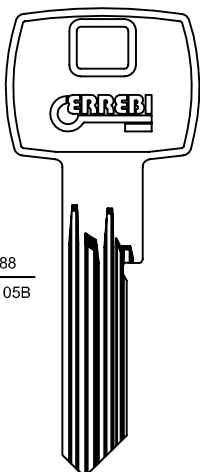
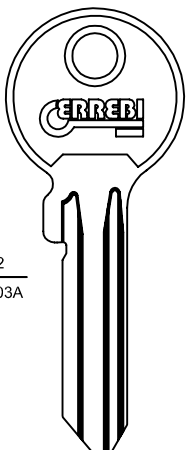
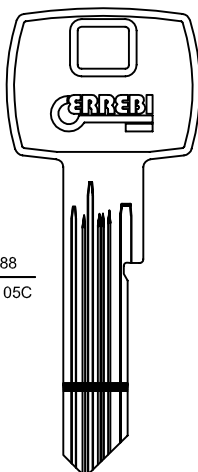

Errebi - news

01 2021

ABUS		ECM		FIC LOCKS	
 $\frac{-}{S 05D}$		 $\frac{12}{S 03S}$		 $\frac{-}{B 05C}$	
 AU111		 EC5		 FCL1R	
 AU112					
 AU113					
GEGE	IVANA	KALE	NOXXA		
 $\frac{-}{S 05D}$	 $\frac{488}{B 05B}$	 $\frac{12}{S 03A}$	 $\frac{488}{B 05C}$		
 GG68	 IVA1	 KAL10RT	 NOX1		

PER/FOR:

ABUS (DE)
 ECM (PT)
 FIC LOCKS (US)
 GEGE (AT)
 IVANA (DE)
 KALE (TR)
 NOXXA (NL)

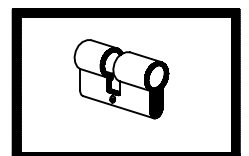









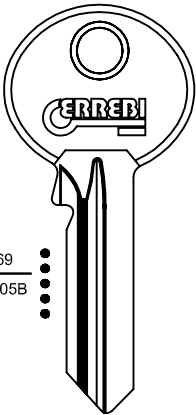

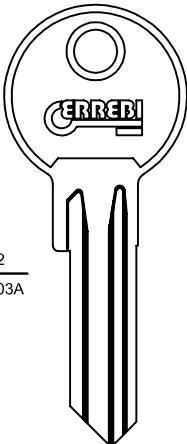

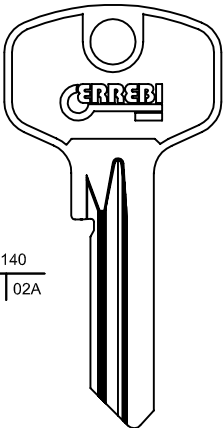

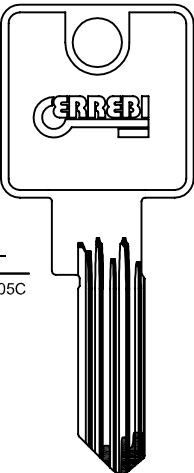

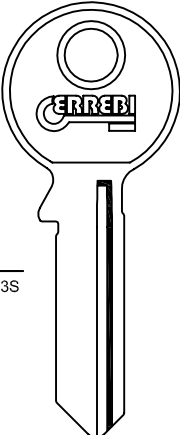
1

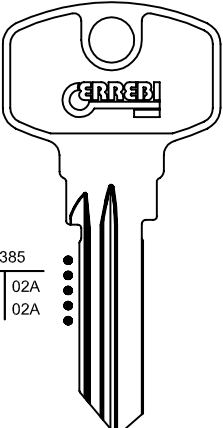
Errebi - news

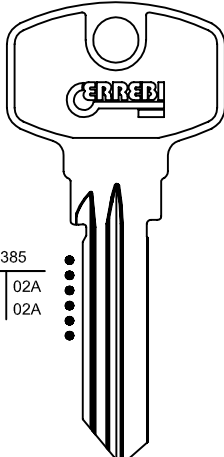
01 2021

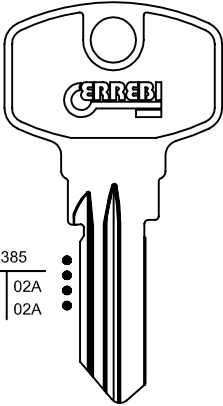
PER/FOR:

RUKO	SATURN	SECUREMME	TOK-WINKHAUS
 <p>269 B 05B</p>  <p>RU47R</p>	 <p>12 S 03A</p>  <p>SAT4R</p>	 <p>140 B 02A</p>  <p>SEM11</p>	 <p>-- S 05C</p>  <p>ENAX TK42</p>
TRI-CIRCLE	YALE (I)		
 <p>-- S 03S</p>  <p>TR26</p>	 <p>385 B 02A S 02A</p>  <p>Y125</p>	 <p>385 B 02A S 02A</p>  <p>Y126</p>	 <p>385 B 02A S 02A</p>  <p>Y127</p>



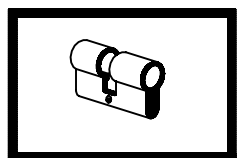

RUKO (DK)
SATURN (SI)
SECUREMME (IT)
TOK-WINKHAUS(DE)
TRI-CIRCLE (SA)
YALE (IT)

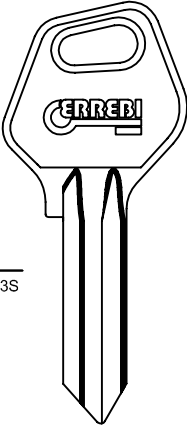

2

Errebi - news

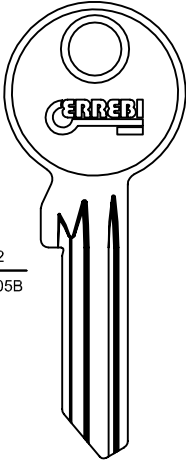
01 2021

WEBSTER	ZEISS-IKON
 <p>-- S 03S</p>  <p>WBS1R</p>	 <p>12 S 05B</p>  <p>ZE500L</p>

PER/FOR:

WEBSTER (GB)
ZEISS-IKON (DE)



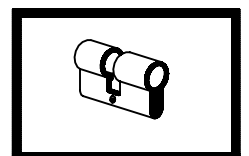







ERREBI

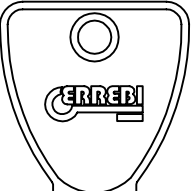

3

Errebi - news

01 2021

ABUS	MCM	SECUREMME	TITAN
 <p data-bbox="87 1041 143 1086">B 06B</p>  <p data-bbox="167 1332 247 1366">AU109</p>	 <p data-bbox="391 1041 446 1086">B 06B</p>  <p data-bbox="574 1332 646 1366">MD30</p>	 <p data-bbox="694 1041 750 1086">P B 07A</p>  <p data-bbox="869 1332 965 1366">SEM10P</p>	 <p data-bbox="997 1041 1053 1086">B 06B</p>  <p data-bbox="1189 1332 1260 1366">TT28</p>
UCEM			
 <p data-bbox="87 1736 143 1780">B 06B</p>  <p data-bbox="263 2004 327 2038">UE14</p>			

PER/FOR:

ABUS (DE)
MCM (ES)
SECUREMME (IT)
TITAN (SI)
UCEM (ES)

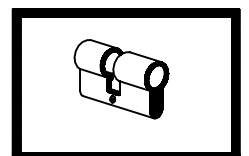









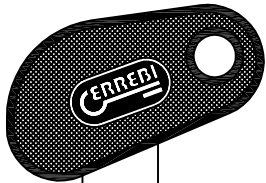

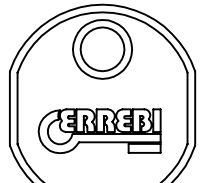
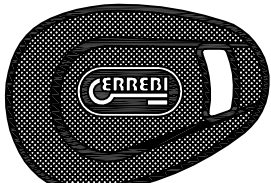

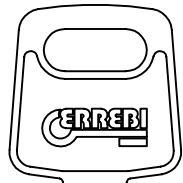
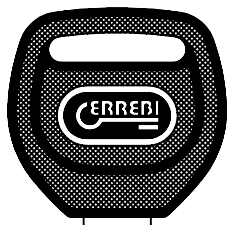
4

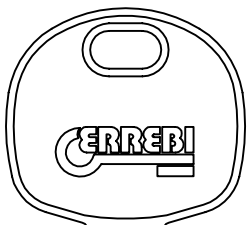
Errebi - news

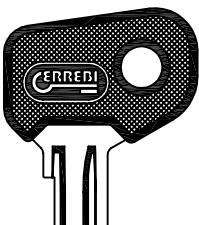
01 2021

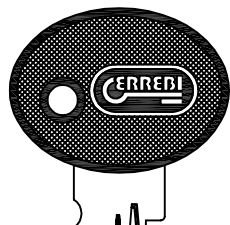
PER/FOR:

ABUS	GIOBERT	GIVI	HONDA
 <p>— S 20A</p>  <p>K1 EVD AU108P</p>	 <p>23A S 17A</p> <p>SECONDARY</p> <p>J... 3001-6732 N... 6001-7000</p> <p>GB11R</p>	 <p>P B 20S</p>  <p>GIV1P GIV2RP</p>	 <p>824 S 17S</p> <p>7-8-9-10</p> <p>HD25R</p>
HONDA	ISUZU	SAFE	SIPEA
 <p>P113 S 20A</p>  <p>HD55RP113</p>	 <p>— B 17A S 17A</p>  <p>ISU8</p>	 <p>P S 20S</p> <p>1 0501-1000</p>  <p>129-1P</p>	 <p>— S 20S</p> <p>H 01-78</p>  <p>SPHP</p>

ABUS (DE)
GIOBERT (IT)
GIVI (IT)
HONDA (JP)
ISUZU (KR)
SAFE (IT)
SIPEA (IT)



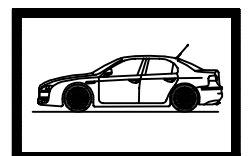

ERREBI

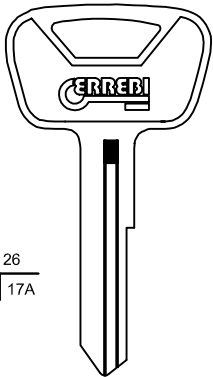
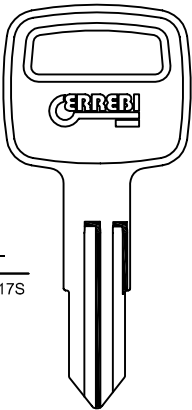

5

Errebi - news

01 2021

TOYOTA	YAMAHA
	
$\frac{126}{S \mid 17A}$	$\frac{-}{S \mid 17S}$
11121-15543 51112-55424	
 6..... TY2	 5..... TY2R
	 YA38
	 YA38R

PER/FOR:

TOYOTA (JP)

YAMAHA (JP)

ERREBI

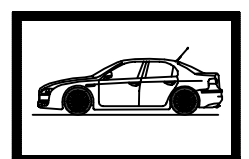

6

Errebi - news

01 2021

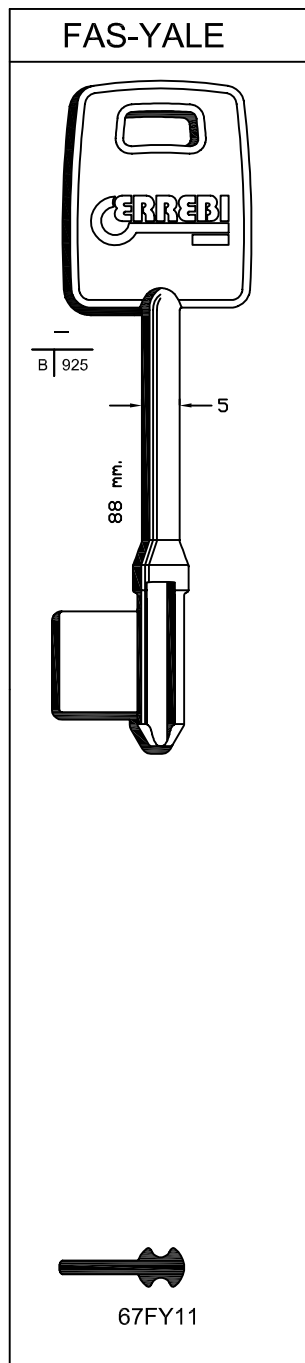

PER/FOR:

FAS-YALE

ERREBI



7

Chiavi sostituite da nuovo modello

PER/FOR:

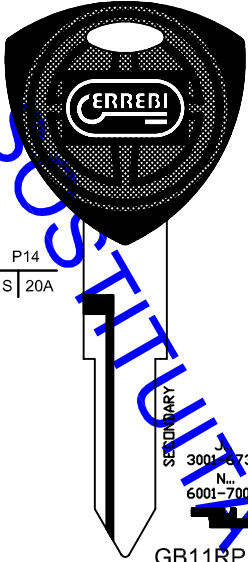
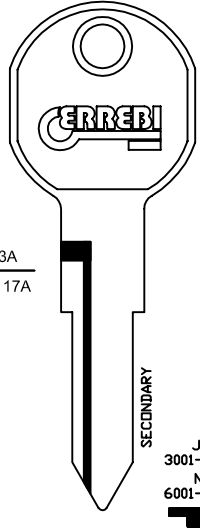
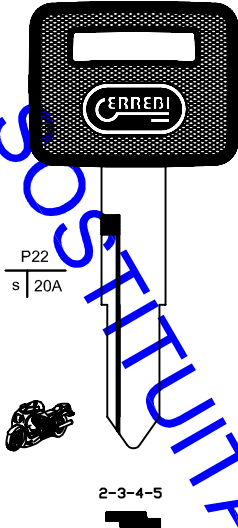
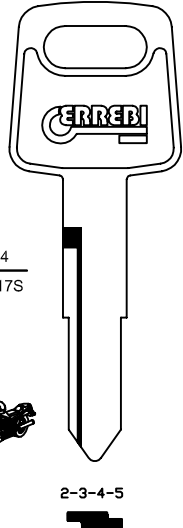
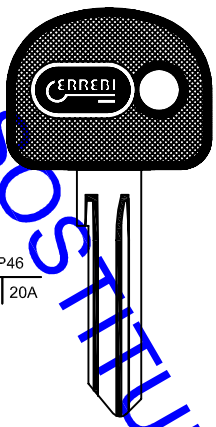
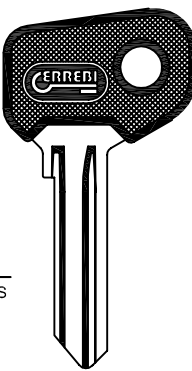
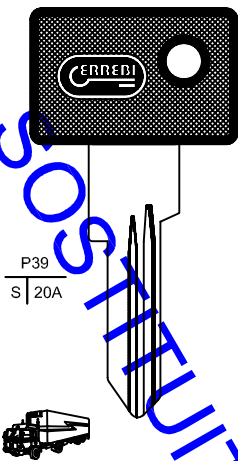
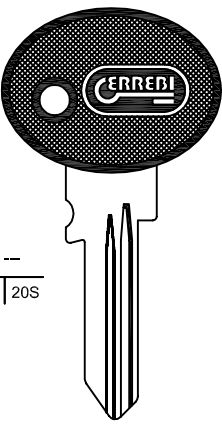
GIOBERT		HONDA	
 <p>P14 S 20A</p> <p>SECONDIARY 3001-6732 N... 6001-7000</p> <p>GB11RP14</p>	 <p>23A S 17A</p> <p>SECONDIARY J... 3001-6732 N... 6001-7000</p> <p>GB11R</p>	 <p>P22 s 20A</p> <p>2-3-4-5</p> <p>HD25RP22</p>	 <p>824 S 17S</p> <p>2-3-4-5</p> <p>HD25R</p>
SAFE		SIPEA	
 <p>P46 S 20A</p> <p>1 0501-1000</p> <p>129-1P46</p>	 <p>P S 20S</p> <p>1 0501-1000</p> <p>129-1P</p>	 <p>P39 S 20A</p> <p>H 01-78</p> <p>SPHP39</p>	 <p>-- S 20S</p> <p>H 01-78</p> <p>SPHP</p>

GIOBERT (IT)
HONDA (JP)
SAFE (IT)
SIPEA (IT)

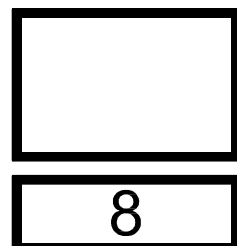



Errebi s.p.a. Unipersonale
Cibiana (BL) - ITALY
Tel. 0435 542 500
Fax. 0435 542 522
www.errebispa.com
info@errebispa.com

Errebi Deutschland GmbH
Velbert - GERMANY
Tel. (02053) 49 62-0
Fax. (02053) 49 62-22
www.errebi-gmbh.de
info@errebi-gmbh.de

*Member of
Altuna Group*