

GUIDA ALLA DUPLICAZIONE
FRÄSSYSTEME FÜR SCHLÜSSEL
DUPLICATION SYSTEMS
SYSTEME DE REPRODUCTION DE CLES

2022

ERREBI

INTRODUZIONE EINLEITUNG - INTRODUCTION - INTRODUCTION	4
AVVERTENZE LEGALI RECHTLICHE HINWEISE- LEGAL WARNING -INFORMATIONS LEGALES	5
PER CHIAVI A CILINDRO EUROPEO / TRACCIATE / TUBOLARI FÜR BAHNEN- UND BOHRMULDENSCHLÜSSEL FOR SECURITY KEYS POUR CLES DE SECURITE	7 - 48
MACCHINE DUPLICATRICI SCHLÜSSELKOPIERMASCHINEN KEY CUTTING MACHINES MACHINES DUPLICATRICES	7 - 12
GUIDA ALLA DUPLICAZIONE FRÄSSYSTEME FÜR SCHLÜSSEL DUPLICATION SYSTEMS SYSTEME DE REPRODUCTION DE CLES	13 - 48
PER CHIAVI A CILINDRO FÜR ZYLINDERSCHLÜSSEL FOR FLAT KEYS POUR CLE PLATES	49 - 57
MACCHINE DUPLICATRICI SCHLÜSSELKOPIERMASCHINEN KEY CUTTING MACHINES MACHINES DUPLICATRICES	49 - 54
GUIDA ALLA DUPLICAZIONE FRÄSSYSTEME FÜR SCHLÜSSEL DUPLICATION SYSTEMS SYSTEME DE REPRODUCTION DE CLES	55 - 58
CHIAVI DOPPIA MAPPA FÜR CHUBB- UND TRESORSCHLÜSSEL FOR BIT KEYS POUR CLES À GORGES	59 -66
MACCHINE DUPLICATRICI SCHLÜSSELKOPIERMASCHINEN KEY CUTTING MACHINES MACHINES DUPLICATRICES	59 - 62
GUIDA ALLA DUPLICAZIONE FRÄSSYSTEME FÜR SCHLÜSSEL DUPLICATION SYSTEMS SYSTEME DE REPRODUCTION DE CLES	63 - 66
CHIAVI SCHLÜSSEL - KEYS - CLES	67 - 111

QUALITÀ



SERVIZIO



RISPETTO PER L'AMBIENTE



INNOVAZIONE

ITALIANO

ERREBI è un'azienda che dal 1949 produce nello stabilimento di Cibiana di Cadore (BL) chiavi per serrature. Forte di una tradizione in loco per la chiave che risale al XVIII secolo, ERREBI ha saputo svilupparsi nel tempo cogliendo le opportunità di mercato fino a diventare una delle aziende leader nel suo settore. La gamma produttiva si è sviluppata nel tempo. Oltre alle chiavi tradizionali siamo in grado di fornire un'ampia scelta di prodotti tecnologicamente avanzati quali: chiavi transponder, chiavi di sicurezza, macchine duplicatrici altamente sofisticate ad altro ancora.

Alla base del nostro successo sta una lunga esperienza accompagnata da una costante attenzione alla qualità, al servizio, all'innovazione tecnologica e al rispetto per l'ambiente. Non ultimo una grande passione per il nostro lavoro ed attenzione particolare alle risorse umane ci completano il profilo.

L'ingresso nel Gruppo Altuna (JMA), leader in Europa nel settore chiavi, ci ha infine fornito le sinergie per continuare nel nostro sviluppo e guardare al futuro con grande ottimismo.

DEUTSCH

Die Firma ERREBI spa produziert seit 1949 im italienischen Stammwerk in Cibiana di Cadore (BL) Schlüssel für verschiedene Schlosshersteller und für Schlüsseldienste in der ganzen Welt.

Eine langjährige Tradition, die bis auf das 18. Jahrhundert zurückgeht, hat dazu beigetragen, sich stetig weiterzuentwickeln und in dieser Branche ein führendes Unternehmen zu werden.

Neben traditionellen Schlüsseln bieten wir auch eine große Auswahl an technologisch hochentwickelten Produkten wie Transponderschlüssel, Sicherheitsschlüssel, moderne Schlüsselfräsmaschinen und einiges mehr an.

Unser Erfolg basiert auf langjähriger Erfahrung, sowie ständigen Verbesserungen in Qualität, Kundenservice, technischen Neuerungen und einem Bewusstsein für die Umwelt. Unser Profil wird nicht zuletzt auch durch eine große Leidenschaft für unsere Arbeit und durch eine besondere Aufmerksamkeit gegenüber unseren Mitarbeitern vervollständigt.

Der Eintritt in die ALTUNA Gruppe, marktführend im Bereich der Schlüsselproduktion in Europa, hat uns die nötigen Synergien geliefert um unsere Entwicklung fortzusetzen und der Zukunft mit großem Optimismus entgegen zu sehen.

ENGLISH

Since 1949 ERREBI has produced key blanks for locks at its factory in CIBIANA DI CADORE (BL). With a long tradition in key blank manufacturing dating from the XVII century, ERREBI has used its knowledge to develop over time, using market opportunities to become one of the leading companies in its sector. During these years the production range has developed from traditional key blank manufacturing to include today the supply of a wide range of high technology products e.g. transponder keys, high security keys, sophisticated keycutting machines and more.

Errebi's success is based on a long experience together with continued and constant care to quality, service, technological innovation and protection of the environment along with a great passion and particular care of its staff.

Lastly, joining the Altuna Group, leader in Europe in the keys blanks market, has provided the synergies to continue and enhance our development and look to the future with great optimism.

FRANÇAIS

ERREBI est une entreprise qui fabrique des clés pour serrures depuis 1949 dans l'usine située à CIBIANA DI CADORE (BELLUNO -Italie).

De plus elle a une grande tradition dans la fabrication de clés à partir du XVIII siècle. ERREBI s'est développée pendant des années, en saisissant les occasions du marché jusqu'à devenir un des leaders dans le secteur de la clé.

Notre gamme de produits s'est élargie au fil des années et offre désormais les clés traditionnelles mais aussi les clés de voiture avec transpondeur, clés de sécurité et les machines à clés reproductives les plus sophistiquées.

Nous devons notre succès à une longue expérience ainsi qu'une continuelle attention à la qualité, au service, à l'innovation technologique et au respect de l'environnement, ainsi qu'une grande passion pour notre travail et une attention particulière aux ressources humaines.

L'entrée dans le groupe ALTUNA, leader européen, nous a enfin fourni les synergies pour poursuivre notre essor et nous tourner vers l'avenir avec beaucoup d'optimisme.

AVVERTENZE LEGALI - RECHTLICHE HINWEISE

LEGAL WARNING - INFORMATIONS LEGALES

ITALIANO

In accordo alle correnti disposizioni legali relative alla proprietà industriale, i marchi ed i nomi commerciali indicati in questo catalogo sono di proprietà esclusiva dei produttori dei cilindri e delle serrature, così come dei produttori delle automobili.

Questi marchi o nomi commerciali sono utilizzati come mera informazione al fine di riconoscere rapidamente la serratura alla quale corrispondono i nostri prodotti.

Questo catalogo è riservato esclusivamente ai duplicatori di chiavi professionali che utilizzano prodotti Errebi. I dati che fanno riferimento ai prodotti di questo catalogo sono meramente informativi.

Sempre mantenendo le caratteristiche di base, ci riserviamo il diritto di effettuare, senza notifiche preventive ed al fine di miglioramenti dei prodotti in questione, modifiche tecniche, estetiche o di altro tipo.

DEUTSCH

Gemäß den geltenden gesetzlichen Bestimmungen bezüglich des gewerblichen Eigentums, der Marken oder Handelsnamen, die in diesem Katalog angegeben sind, sind diese ausschließliches Eigentum der Hersteller der Zylinder und Schlösser sowie der Fahrzeughersteller. Diese Marken oder Handelsnamen werden aus rein informativen Gründen angegeben, um die Schlösser, zu denen unsere Teile gehören, schneller zu erkennen.

Dieser Katalog ist ausschließlich für Fachleute auf dem Gebiet der Reproduktion von Schlüsseln gedacht, die Teile von Errebi verwenden. Die Daten bezüglich der Produkte dieses Katalogs haben indikativen Charakter. Unter Beibehaltung der grundlegenden Charakteristiken behalten wir uns das Recht vor, ohne Vorankündigung technische, ästhetische oder sonstige Modifikationen aufgrund der Weiterentwicklung der fraglichen Produkte vorzunehmen.

ENGLISH

In accordance with current legal dispositions related to industrial property, the brands or commercial names indicated in this catalogue are the exclusive property of the manufacturers of cylinders and locks, as well as the manufacturers of automobiles. These brands or commercial names are used as mere information in order to quickly recognise the lock to which our parts correspond.

This catalogue is exclusively reserved to professional key duplicators that use Errebi products. The data referring to the products of this catalogue is merely informative.

Always maintaining the basic characteristics, we reserve the right to making, without previous notifications, technical, aesthetic or other types of modifications, for improvement reasons of the products in questions.

FRANÇAIS

Conformément aux dispositions légales en vigueur relatives à la propriété industrielle, les marques ou les dénominations commerciales citées dans ce catalogue sont la propriété exclusive des fabricants de cylindres et de serrures ainsi que des constructeurs de voitures, autres constructeurs, distributeurs et utilisateurs. Ces marques ou dénominations commerciales sont indiquées à titre de simple information afin de connaître rapidement à quelle serrure nos ébauches sont destinées.

Ce catalogue est exclusivement réservé aux professionnels de la reproduction de clés, utilisant des ébauches Errebi. Les renseignements sur les produits de ce catalogue sont donnés à titre indicatif. Tout en gardant les caractéristiques de base, nous nous réservons le droit d'apporter, sans préavis, des modifications techniques, esthétiques ou autres, dues à l'évolution des produits en question.



MACCHINE MECCANICHE

MECHANISCHE MASCHINEN
MECHANICAL MACHINES
MACHINES MECANIQUES

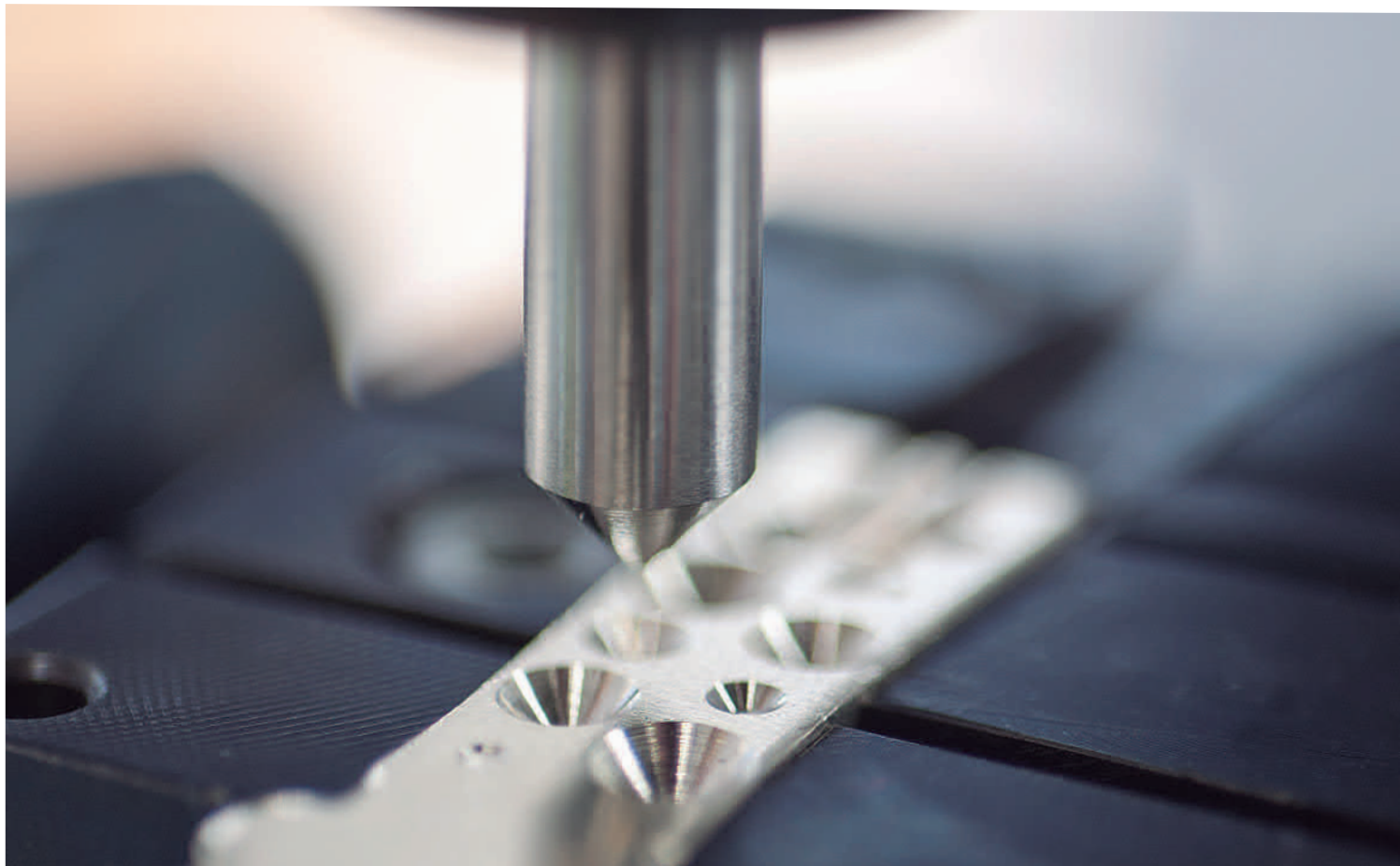

PER CHIAVI A CILINDRO EUROPEO / TRACCIATE / TUBOLARI
FÜR BAHNEN- UND BOHRMULDENSCHLÜSSEL
FOR SECURITY KEYS
POUR CLES DE SECURITE

DAKAR EVOLUTION - DAKAR UP - DAKAR EASY

CERREBI[®]



PER CHIAVI A CILINDRO EUROPEO / TRACCIATE / TUBOLARI FÜR BAHNEN- UND BOHRMULDENSCHLÜSSEL - FOR SECURITY KEYS - POUR CLES DE SECURITE

DAKAR EVOLUTION



DAKAR EVOLUTION è la duplicatrice manuale di ERREBI per chiavi punzonate, tracciate e tubolari. La DAKAR EVOLUTION ti porta ad un livello superiore di duplicazione, offrendo grande versatilità ed incorporando un innovativo sistema di indicazione della pressione utilizzata nella duplicazione, permettendo una lavorazione più semplice e precisa. Dotata di taratura elettronica.

DAKAR EVOLUTION is a duplicating machine for security, laser and special keys. DAKAR EVOLUTION takes you to a higher level of duplication by giving a great versatility and including an innovative patented system for measuring the strength of pressure in the duplication making the copy easy and precise. Electronic adjustment system.

Die DAKAR EVOLUTION Schlüsselkopierfräse für Bahnen- und Bohrmuldenschlüssel, Tibbeschlüssel und andere Spezialschlüssel. Mit der DAKAR EVOLUTION Schlüsselkopierfräse sind wir einen guten Schritt weiter, als die gängigen am Markt verfügbaren manuellen und vergleichbaren Schlüsselkopierfräsen. Dies haben wir durch den Einsatz eines patentierten Systems für die Berechnung der Kraft und des Drucks erreicht, wodurch das Kopieren wesentlich erleichtert und präziser geworden ist. Elektronische Einstellhilfe

DAKAR EVOLUTION est une machine ERREBI pour clés radiales, laser et tubulaires. La DAKAR EVOLUTION vous amène à un niveau supérieur de duplication en vous donnant une grande précision et un système innovant d'indication de la pression utilisée dans la reproduction en vous permettant une copie plus simple et précise. Système de réglage électronique.

DAKAR UP



La DAKAR UP è la duplicatrice manuale di ERREBI per chiavi punzonate e tracciate. La DAKAR UP è la versione semplificata della DAKAR EVOLUTION, che ne mantiene la medesima struttura, garantendovi una duplicazione semplice e di qualità. Dotata di taratura elettronica.

DAKAR UP is a duplicating machine for security, laser and special keys. It is the simple version of the DAKAR EVOLUTION by keeping the same structure and thanks to the new technologies and last generation materials it guarantees an easy and high quality copy. Electronic adjustment system.

Die DAKAR UP Schlüsselkopierfräse für Bahnen- und Bohrmuldenschlüssel, Tibbeschlüssel und andere Spezialschlüssel. Die DAKAR UP Schlüsselkopierfräse wurde in Zusammenarbeit mit Experten aus der Welt des Schlüsselkopierens entwickelt. Sie stellt eine vereinfachtere Variante der DAKAR EVOLUTION dar. Die geraden Designlinien und die eingesetzten neuesten und haltbaren Materialien machen die DAKAR UP zu einer dauerhaften Schlüsselkopierfräse, die eine Genauigkeit beim Schlüsselkopieren gewährleistet. Elektronische Einstellhilfe.

La DAKAR UP est une machine semi-automatique pour la reproduction de clés radiales et laser faite pour des professionnels. Il s'agit d'une version plus simple de la machine DAKAR EVOLUTION. Solide d'un bon design. Dans des matériaux modernes qui maintiennent une haute précision dans la reproduction. Système de réglage électronique.

DAKAR EASY



La DAKAR EASY è la duplicatrice semiautomatica per chiavi punzonate e tracciate rivolta a chi vuole affacciarsi alla duplicazione di queste tipologie di chiavi. La DAKAR EASY presenta il nuovo morsetto che permette di duplicare anche le chiavi auto di MERCEDES® e gruppo VAG®, senza necessità di utilizzare adattatori.

DAKAR EASY is a simple duplicating machine for security, laser and special keys for those who approach the duplication of this kind of keys. DAKAR EASY features the new clamp that allows the duplication of MERCEDES® and VAG® Group keys, without any other adaptors.

Die DAKAR EASY Schlüsselkopierfräse vereint Präzision und Einfachheit, um Bahnen- und Bohrmuldenschlüssel, Tibbeschlüssel und andere Spezialschlüssel zu kopieren. Sie enthält Neuheiten, wie z. B. die LED-Beleuchtung und eine Plexiglasabschirmung des Arbeitsbereiches. Zudem stellt die DAKAR EASY in ihrer Klasse ein Novum dar, denn die Spannbacken sind passend für Bahnen- und Bohrmuldenschlüssel und enthalten bereits Adapter für Autoschlüssel der Marken VAG® und MERCEDES®.

La DAKAR EASY est une machine semi-automatique de précision pour les clés radiales et laser. La DAKAR EASY agit avec un nouvel étai qui permet de copier les clés de voitures MERCEDES® et du groupe VAG® sans utiliser aucun adaptateur.



FRESE - FRÄSER - CUTTERS - FRAISES

CODICE	A	B	C	D	E	PER-FOR	MAT
BF3-3T			2	45	6	DAKAR EV-DAKAR UP-DAKAR EA-Dakar-Dakar ex	HSS
BF12	82	0,6		45	6	DAKAR EV-DAKAR UP-DAKAR EA-Dakar-Dakar ex	HSS
F1	90	0,8		45	6	DAKAR EV-DAKAR UP-DAKAR EA-Dakar-Dakar ex	HSS
F1A	90	0,8		45	8	DAKAR EV-DAKAR UP-DAKAR EA-Dakar-Dakar ex	HSS
F1W	90	0,8		45	6	DAKAR EV-DAKAR UP-DAKAR EA-Dakar-Dakar ex	W
F3			1,5	45	6	DAKAR EV-DAKAR UP-DAKAR EA-Dakar-Dakar ex	HSS
F3V			1,5 (L)	45	6	DAKAR EV-DAKAR UP-DAKAR EA-Dakar-Dakar ex	HSS
F5	90	1		45	6	DAKAR EV-DAKAR UP-DAKAR EA-Dakar-Dakar ex	HSS
F6	106	1		45	6	DAKAR EV-DAKAR UP-DAKAR EA-Dakar-Dakar ex	HSS
F8			4	45	6	DAKAR EV-DAKAR UP-DAKAR EA-Dakar-Dakar ex	HSS
F8W			4	45	6	DAKAR EV-DAKAR UP-DAKAR EA-Dakar-Dakar ex	W
F11			2,5	45	6	DAKAR EV-DAKAR UP-DAKAR EA-Dakar-Dakar ex	HSS
F11W			2,5	45	6	DAKAR EV-DAKAR UP-DAKAR EA-Dakar-Dakar ex	W
F12A	100	0,6		45	6	DAKAR EV-DAKAR UP-DAKAR EA-Dakar-Dakar ex	HSS
F12B	100-90	2,1-2,9		45	6	DAKAR EV-DAKAR UP-DAKAR EA-Dakar-Dakar ex	HSS
F13	100	0,8		45	6	DAKAR EV-DAKAR UP-DAKAR EA-Dakar-Dakar ex	HSS
F13W	100	0,8		45	6	DAKAR EV-DAKAR UP-DAKAR EA-Dakar-Dakar ex	W
F14	100	1,45		45	6	DAKAR EV-DAKAR UP-DAKAR EA-Dakar-Dakar ex	HSS
F15		2	5	45	6	DAKAR EV-DAKAR UP-DAKAR EA-Dakar-Dakar ex	HSS
F16	130	0,6		45	6	DAKAR EV-DAKAR UP-DAKAR EA-Dakar-Dakar ex	HSS
F17			3	45	6	DAKAR EV-DAKAR UP-DAKAR EA-Dakar-Dakar ex	HSS
F19	90	1,2		45	6	DAKAR EV-DAKAR UP-DAKAR EA-Dakar-Dakar ex	HSS
F20	90	0,45		45	6	DAKAR EV-DAKAR UP-DAKAR EA-Dakar-Dakar ex	HSS
F21	85	0,72		45	6	DAKAR EV-DAKAR UP-DAKAR EA-Dakar-Dakar ex	HSS
F22-3T			2,4	40	6	DAKAR EV-DAKAR UP-DAKAR EA-Dakar-Dakar ex	HSS
F23	90	0,8	3,3	45	6	DAKAR EV-DAKAR UP-DAKAR EA-Dakar-Dakar ex	HSS
F26	90	0,6	1,8	45	6	DAKAR EV-DAKAR UP-DAKAR EA-Dakar-Dakar ex	HSS
F32	90	0,6	3	45	6	DAKAR EV-DAKAR UP-DAKAR EA-Dakar-Dakar ex	HSS
F34	90	1,4		45	6	DAKAR EV-DAKAR UP-DAKAR EA-Dakar-Dakar ex	HSS
F35W			3	45	6	DAKAR EV-DAKAR UP-DAKAR EA-Dakar-Dakar ex	W
F40	90	0,2		45	6	DAKAR EV-DAKAR UP-DAKAR EA-Dakar-Dakar ex	HSS
F43	90	0,7	2,6	45	6	DAKAR EV-DAKAR UP-DAKAR EA-Dakar-Dakar ex	HSS
FB	90	2,7-3,3		45	6	DAKAR EV-DAKAR UP-DAKAR EA-Dakar-Dakar ex	HSS
FC	80	1,4-2,0		45	6	DAKAR EV-DAKAR UP-DAKAR EA-Dakar-Dakar ex	HSS
FS31	60	0,64-1,2		45	6	DAKAR EV-DAKAR UP-DAKAR EA-Dakar-Dakar ex	HSS

Codice	F	G	C	D	E	PER-FOR	MAT
F18	10	1		45	6	DAKAR EV-Dakar	HSS

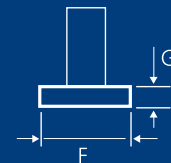
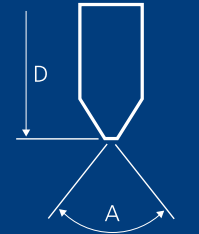

SIMBOLI - SYMBOLIK - SYMBOLS



MACCHINA PER CHIAVI A CILINDRO EUROPEO - TRACCIATE - TUBOLARI
 BAHNEN- UND BOHRMULDENSCHLÜSSEL
 MACHINES FOR SECURITY KEYS
 MACHINES POUR CLES DE SECURITE



FRESE
 FRÄSER
 CUTTERS
 FRAISES



TASTATORI
 TASTER
 TRACERS
 PALPEURS



ADATTATORI
 ADAPTER
 ADAPTORS
 ADAPTEURS



HSS
 Acciaio Super rapido
 Schnellarbeitsstahl
 High-speed steel
 Acier extra rapide



Larghezza gambo fresa
 Aufnahme
 Cutting distance
 Distance coupe



Angolo di taglio
 Schnittwinkel
 Cutting angle
 Angle de coupe



Diametro
 Durchmesser
 Diameter
 Diametre



Pianetto
 Basis
 Base
 Base



Spessore della fresa
 Schnitttiefe
 Cutting height
 Hauteur de coupe



Diametro della fresa
 Durchmesser Schneide
 Cutting diameter
 Diamètre de coupe



Altezza fresa
 Länge
 Length
 Longueur



FRESE - FRÄSER - CUTTERS - FRAISES

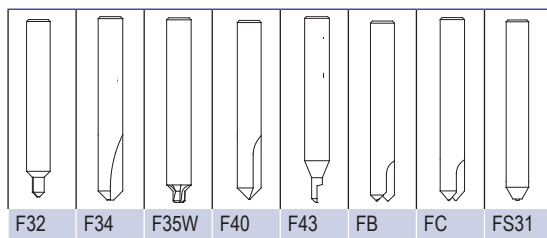
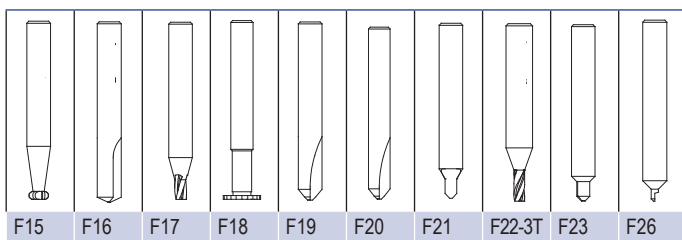
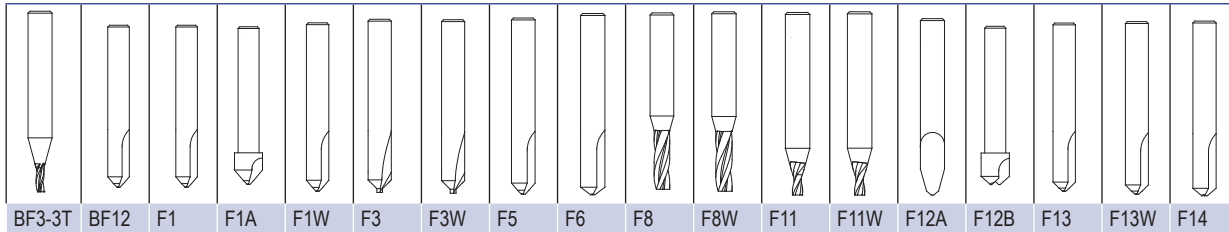

TASTATORI - TASTER - TRACERS - PALPEURS

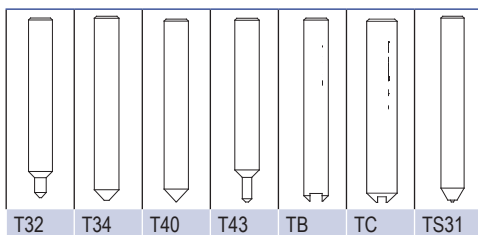
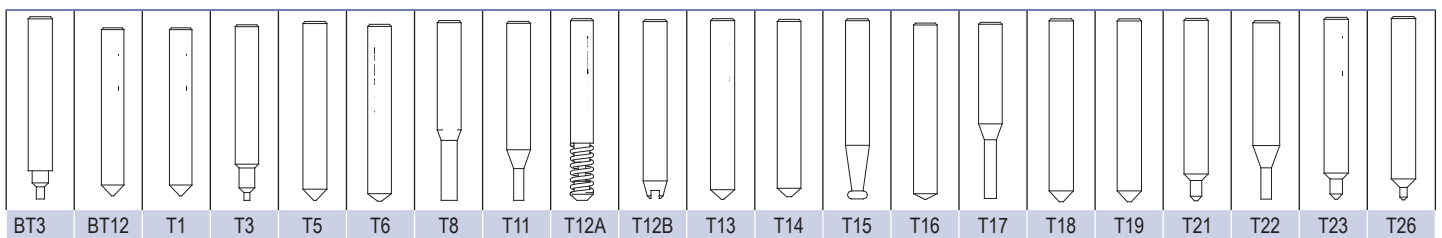

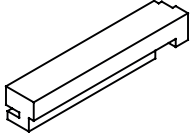
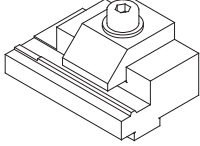
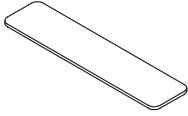
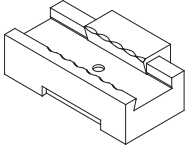
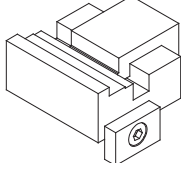
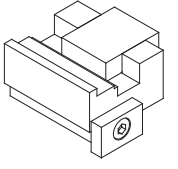
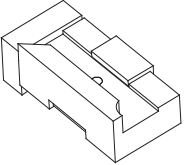
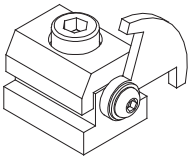
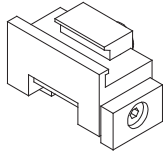
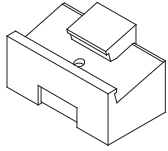
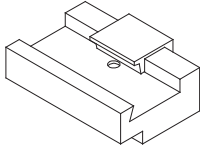
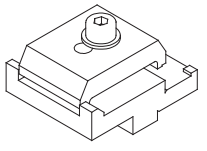
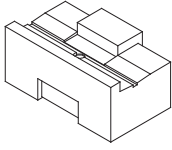
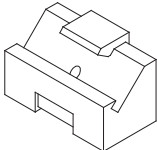
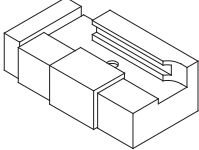
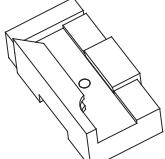
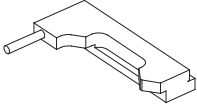
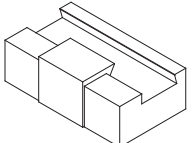
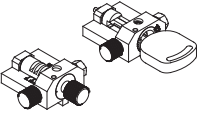
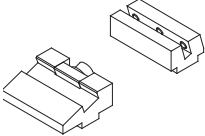
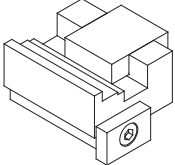
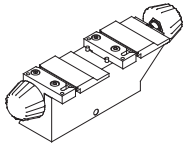
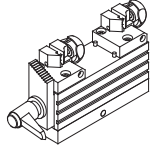
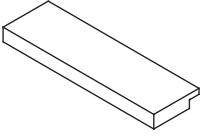

ADATTATORI - ADAPTER - ADAPTORS - ADAPTEURS

					
AD-2H	AD-BKS	AD-BR	AD-CI	AD-DM	AD-DO
					
AD-FD1	AD-JIS	AD-MA	AD-MB	AD-MCM	AD-MJ
					
AD-MK5	AD-MKA	AD-MM	AD-OP	AD-PH	AD-STS
					
AD-TB	AD-VA	AD-VAX	FIC-TUB	FIC-18	P-WIN

ADATTATORE	DAKAR EV	DAKAR UP	DAKAR EASY	DAKAR	DAKAR EXPRESS
AD-2H	X				
AD-BKS	X	X	X	X	X
AD-BR	X	X	X	X	X
AD-CI	X	X	X	X	X
AD-DM	X	X	X	X	X
AD-DO	X	X	X	X	X
AD-FD1		X	X		X
AD-JIS	X	X	X	X	X
AD-MA	X	X	X	X	X
AD-MB		X	X		X
AD-MCM		X	X		X
AD-MJ	X	X	X	X	X
AD-MK5		X	X		X
AD-MKA		X	X		X

ADATTATORE	DAKAR EV	DAKAR UP	DAKAR EASY	DAKAR	DAKAR EXPRESS
AD-MM	X	X	X	X	X
AD-OP	X	X	X	X	X
AD-PH	X	X	X	X	X
AD-PL5	X			X	
AD-SA	X	X	X	X	X
AD-STS	X	X	X	X	X
AD-TB	X	X	X	X	X
AD-VA		X	X		X
AD-VAX	X	X	X	X	X
AD-VO	X	X	X	X	X
FIC-18	X			X	
FIC-TUB		X			X
PIA-MKB	X	X	X	X	X
P-WIN		X	X		X

GUIDA ALLA DUPLICAZIONE

FRÄSSYSTEME FÜR SCHLÜSSEL
DUPLICATION SYSTEMS
SYSTEME DE REPRODUCTION DE CLES

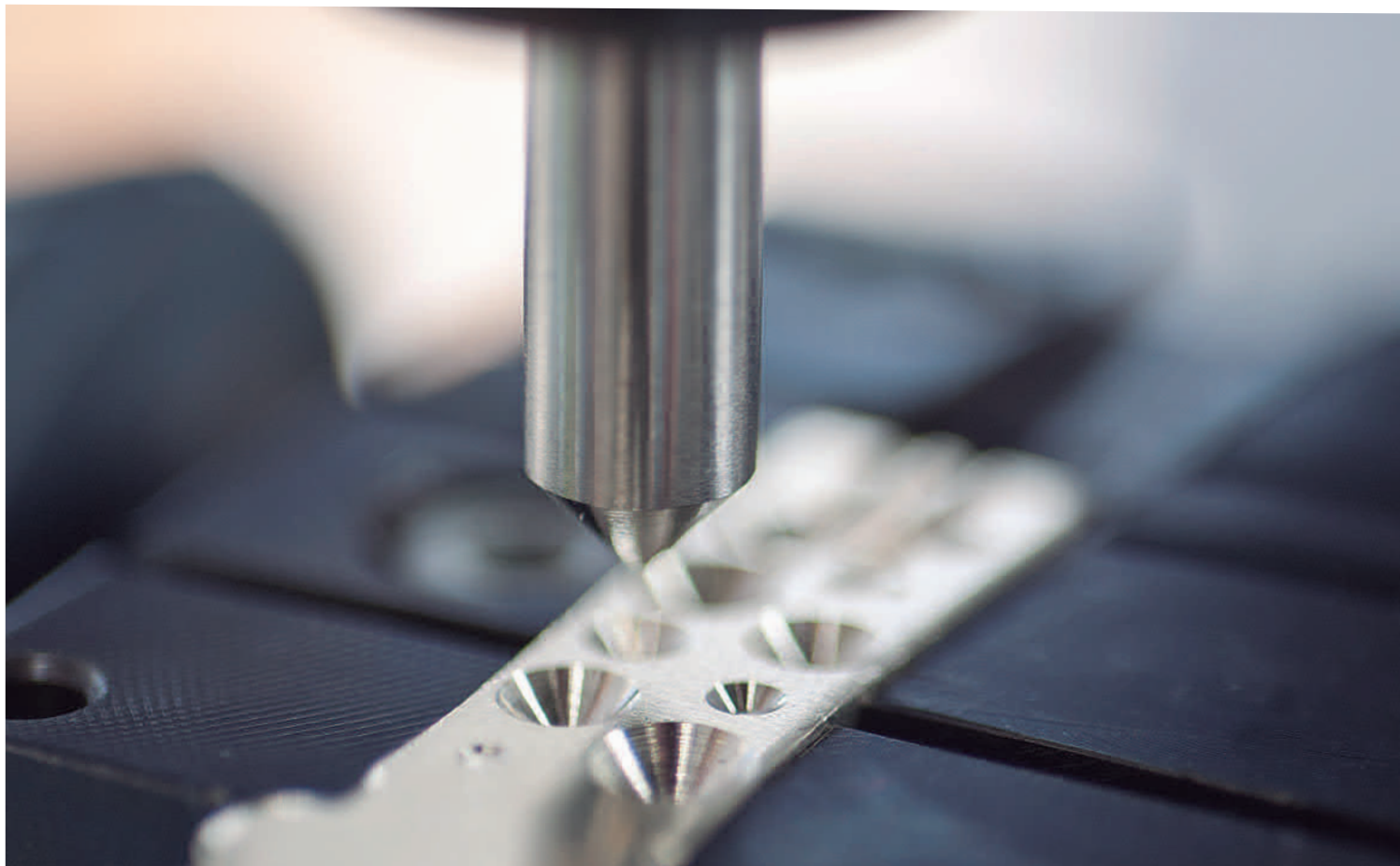

PER CHIAVI A CILINDRO EUROPEO – TRACCIATE – TUBOLARI
FÜR BAHNEN- UND BOHRMULDENSCHLÜSSEL
FOR SECURITY KEYS
POUR CLES DE SECURITE

DAKAR EVOLUTION - DAKAR UP - DAKAR EASY

CERREBI®



ABUS®					
AU50	DAKAR EVO	F26	T26		
	DAKAR UP	F26	T26		
	DAKAR EASY	F26	T26		
	Dakar	F26	T26		
	Dakar Express	F26	T26		
AU51	DAKAR EVO	F26	T26		
	DAKAR UP	F26	T26		
	DAKAR EASY	F26	T26		
	Dakar	F26	T26		
	Dakar Express	F26	T26		
AU55	DAKAR EVO	F26	T26		
	DAKAR UP	F26	T26		
	DAKAR EASY	F26	T26		
	Dakar	F26	T26		
	Dakar Express	F26	T26		
AU57L	DAKAR EVO	F26	T26	AD-CI	
	DAKAR UP	F26	T26	AD-CI	
	DAKAR EASY	F26	T26	AD-CI	
	Dakar	F26	T26	AD-CI	
	Dakar Express	F26	T26	AD-CI	
AU57LP	DAKAR EVO	F26	T26	AD-CI	
	DAKAR UP	F26	T26	AD-CI	
	DAKAR EASY	F26	T26	AD-CI	
	Dakar	F26	T26	AD-CI	
	Dakar Express	F26	T26	AD-CI	
AU72	DAKAR EVO	F1	T1	AD-CI	
	DAKAR UP	F1	T1	AD-CI	
	DAKAR EASY	F1	T1	AD-CI	
	Dakar	F1	T1	AD-CI	
	Dakar Express	F1	T1	AD-CI	
AU82	DAKAR EVO	F26	T26	AD-CI	
	DAKAR UP	F26	T26	AD-CI	
	DAKAR EASY	F26	T26	AD-CI	
	Dakar	F26	T26	AD-CI	
	Dakar Express	F26	T26	AD-CI	
AU84	DAKAR EVO	F26	T26	AD-CI	
	DAKAR UP	F26	T26	AD-CI	
	DAKAR EASY	F26	T26	AD-CI	
	Dakar	F26	T26	AD-CI	
	Dakar Express	F26	T26	AD-CI	
AU91L	DAKAR EVO	F26	T26	AD-CI	
	DAKAR UP	F26	T26	AD-CI	
	DAKAR EASY	F26	T26	AD-CI	
	Dakar	F26	T26	AD-CI	
	Dakar Express	F26	T26	AD-CI	



ABUS®					
AU103	DAKAR EVO	F1	T1	AD-CI	
	DAKAR UP	F1	T1	AD-CI	
	DAKAR EASY	F1	T1	AD-CI	
	Dakar	F1	T1	AD-CI	
	Dakar Express	F1	T1	AD-CI	
AU105R	DAKAR EVO	F34	T34	AD-PH	
	DAKAR UP	F34	T34	AD-PH	
	DAKAR EASY	F34	T34	AD-PH	
	Dakar	F34	T34	AD-PH	
	Dakar Express	F34	T34	AD-PH	
AU106	DAKAR EVO	F34	T34	AD-PH	
	DAKAR UP	F34	T34	AD-PH	
	DAKAR EASY	F34	T34	AD-PH	
	Dakar	F34	T34	AD-PH	
	Dakar Express	F34	T34	AD-PH	
AU109	DAKAR EVO	F1	T1	AD-CI	
	DAKAR UP	F1	T1	AD-CI	
	DAKAR EASY	F1	T1	AD-CI	
	Dakar	F1	T1	AD-CI	
	Dakar Express	F1	T1	AD-CI	
ORIGINAL BRAVUS	DAKAR EVO	F40	T40	AD-BR	
	DAKAR UP	F40	T40	AD-BR	
	DAKAR EASY	F40	T40	AD-BR	
	Dakar	F40	T40	AD-BR	
	Dakar Express	F40	T40	AD-BR	
AGA®	AGA12	DAKAR EVO	F13	T13	
	DAKAR UP	F13	T13		
	DAKAR EASY	F13	T13		
	Dakar	F13	T13		
	Dakar Express	F13	T13		
AGA13	AGA13	DAKAR EVO	F13	T13	
	DAKAR UP	F13	T13		
	DAKAR EASY	F13	T13		
	Dakar	F13	T13		
	Dakar Express	F13	T13		
AGA14	AGA14	DAKAR EVO	F1	T1	
	DAKAR UP	F1	T1		
	DAKAR EASY	F1	T1		
	Dakar	F1	T1		
	Dakar Express	F1	T1		
AGA15	AGA15	DAKAR EVO	F1	T1	
	DAKAR UP	F1	T1		
	DAKAR EASY	F1	T1		
	Dakar	F1	T1		

FOR:**AGA®**

AGA15	Dakar Express	F1	T1	
AGA19T	DAKAR EVO	F8	T8	
	DAKAR UP	F8	T8	FIC-TUB
	Dakar	F8	T8	
	Dakar Express	F8	T8	FIC-TUB
AGA20T	DAKAR EVO	F8	T8	
	DAKAR UP	F8	T8	FIC-TUB
	Dakar	F8	T8	
	Dakar Express	F8	T8	FIC-TUB
AGA21	DAKAR EVO	F1	T1	
	DAKAR UP	F1	T1	
	DAKAR EASY	F1	T1	
	Dakar	F1	T1	
	Dakar Express	F1	T1	
AGA22	DAKAR EVO	F1	T1	
	DAKAR UP	F1	T1	
	DAKAR EASY	F1	T1	
	Dakar	F1	T1	
	Dakar Express	F1	T1	
AGA23	DAKAR EVO	F1	T1	
	DAKAR UP	F1	T1	
	DAKAR EASY	F1	T1	
	Dakar	F1	T1	
	Dakar Express	F1	T1	
AGA27	DAKAR EVO	F1	T1	
	DAKAR UP	F1	T1	
	DAKAR EASY	F1	T1	
	Dakar	F1	T1	
	Dakar Express	F1	T1	
AGA28	DAKAR EVO	F1	T1	
	DAKAR UP	F1	T1	
	DAKAR EASY	F1	T1	
	Dakar	F1	T1	
	Dakar Express	F1	T1	
AGA29	DAKAR EVO	F1	T1	
	DAKAR UP	F1	T1	
	DAKAR EASY	F1	T1	
	Dakar	F1	T1	
	Dakar Express	F1	T1	
AGA30	DAKAR EVO	F1	T1	
	DAKAR UP	F1	T1	
	DAKAR EASY	F1	T1	
	Dakar	F1	T1	
	Dakar Express	F1	T1	





AGB®





AGB6	DAKAR EVO	F20	T20	
------	-----------	-----	-----	--

FOR:**AGB®**

AGB6	DAKAR UP	F20	T20	
	DAKAR EASY	F20	T20	
	Dakar	F20	T20	
	Dakar Express	F20	T20	
AGB7	DAKAR EVO	F26	T26	
	DAKAR UP	F26	T26	
	DAKAR EASY	F26	T26	
	Dakar	F26	T26	
	Dakar Express	F26	T26	
AGB8	DAKAR EVO	F26	T26	
	DAKAR UP	F26	T26	
	DAKAR EASY	F26	T26	
	Dakar	F26	T26	
	Dakar Express	F26	T26	
AGB9	DAKAR EVO	F26	T26	
	DAKAR UP	F26	T26	
	DAKAR EASY	F26	T26	
	Dakar	F26	T26	
	Dakar Express	F26	T26	
AGB10	DAKAR EVO	F26	T26	
	DAKAR UP	F26	T26	
	DAKAR EASY	F26	T26	
	Dakar	F26	T26	
	Dakar Express	F26	T26	
AGR2	DAKAR EVO	F1	T1	
	DAKAR UP	F1	T1	
	DAKAR EASY	F1	T1	
	Dakar	F1	T1	
	Dakar Express	F1	T1	
AGR3	DAKAR EVO	F1	T1	
	DAKAR UP	F1	T1	
	DAKAR EASY	F1	T1	
	Dakar	F1	T1	
	Dakar Express	F1	T1	
AMG1	DAKAR EVO	F5	T5	
	DAKAR UP	F5	T5	
	DAKAR EASY	F5	T5	
	Dakar	F5	T5	
	Dakar Express	F5	T5	
AMG1R	DAKAR EVO	F5	T5	
	DAKAR UP	F5	T5	
	DAKAR EASY	F5	T5	
	Dakar	F5	T5	
	Dakar Express	F5	T5	
AMG2	DAKAR EVO	F5	T5	

AHRAM®**AMIG®**

FOR:						
AMIG®	AMG2	DAKAR UP	F5	T5		
		DAKAR EASY	F5	T5		
		Dakar	F5	T5		
		Dakar Express	F5	T5		
	AMG3	DAKAR EVO	F19	T19		
		DAKAR UP	F19	T19		
		DAKAR EASY	F19	T19		
		Dakar	F19	T19		
	APEX®	APE2	DAKAR EVO	F13	T13	
			DAKAR UP	F13	T13	
			DAKAR EASY	F13	T13	
			Dakar	F13	T13	
APE3		DAKAR EVO	F13	T13		
		DAKAR UP	F13	T13		
		DAKAR EASY	F13	T13		
		Dakar	F13	T13		
APE4		DAKAR EVO	F13	T13		
		DAKAR UP	F13	T13		
		DAKAR EASY	F13	T13		
		Dakar	F13	T13		
APE5		DAKAR EVO	F26	T26		
		DAKAR UP	F26	T26		
		DAKAR EASY	F26	T26		
		Dakar	F26	T26		
ASHICO®	ASH1	DAKAR EVO	F26	T26		
		DAKAR UP	F26	T26		
		DAKAR EASY	F26	T26		
		Dakar	F26	T26		
		Dakar Express	F26	T26		
ATRA®	AT12P	DAKAR EVO	F26	T26		
		DAKAR UP	F26	T26		
		DAKAR EASY	F26	T26		
		Dakar	F26	T26		
AUNO®	AUN1R	DAKAR EVO	F1	T1		
		DAKAR UP	F1	T1		
		DAKAR EASY	F1	T1		
		Dakar	F1	T1		
		Dakar Express	F1	T1		

FOR:							
AXA®	AX3P167	DAKAR EVO	BF3N	T3			
		DAKAR UP	BF3N	T3			
		DAKAR EASY	BF3N	T3			
		Dakar	BF3N	T3			
		Dakar Express	BF3N	T3			
		AX3P170	DAKAR EVO	BF3N	T3		
			DAKAR UP	BF3N	T3		
			DAKAR EASY	BF3N	T3		
	Dakar		BF3N	T3			
	Dakar Express		BF3N	T3			
	AX5		DAKAR EVO	F1	T1		
			DAKAR UP	F1	T1		
			DAKAR EASY	F1	T1		
		Dakar	F1	T1			
			Dakar Express	F1	T1		
			AX8P170	DAKAR EVO	BF3N	T3	
				DAKAR UP	BF3N	T3	
				DAKAR EASY	BF3N	T3	
	Dakar	BF3N		T3			
			Dakar Express	BF3N	T3		
			AX10	DAKAR EVO	F1	T1	
				DAKAR UP	F1	T1	
				DAKAR EASY	F1	T1	
	Dakar	F1		T1			
		Dakar Express	F1	T1			
		AZBE®	AZ7	DAKAR EVO	F13	T13	
				DAKAR UP	F13	T13	
				DAKAR EASY	F13	T13	
Dakar	F13			T13			
Dakar Express	F13			T13			
AZ7L	DAKAR EVO	F13	T13				
	DAKAR UP	F13	T13				
	DAKAR EASY	F13	T13				
	Dakar	F13	T13				
	Dakar Express	F13	T13				
AZ7R	DAKAR EVO	F13	T13				
	DAKAR UP	F13	T13				
	DAKAR EASY	F13	T13				
	Dakar	F13	T13				
	Dakar Express	F13	T13				
AZ8	DAKAR EVO	F13	T13				
	DAKAR UP	F13	T13				
	DAKAR EASY	F13	T13				
	Dakar	F13	T13				



AZBE®	AZ8	Dakar Express	F13	T13	
	AZ11	DAKAR EVO	F5	T5	
		DAKAR UP	F5	T5	
		DAKAR EASY	F5	T5	
		Dakar	F5	T5	
		Dakar Express	F5	T5	
	AZ14	DAKAR EVO	F15	T15	
		DAKAR UP	F15	T15	P-WIN
		DAKAR EASY	F15	T15	P-WIN
		Dakar	F15	T15	P-WIN
		Dakar Express	F15	T15	P-WIN
	AZ16	DAKAR EVO	F13	T13	
		DAKAR UP	F13	T13	
		DAKAR EASY	F13	T13	
		Dakar	F13	T13	
		Dakar Express	F13	T13	
	AZ17	DAKAR EVO	F13	T13	
		DAKAR UP	F13	T13	
		DAKAR EASY	F13	T13	
		Dakar	F13	T13	
		Dakar Express	F13	T13	
BAGEM®	BAG1	DAKAR EVO	F1	T1	
		DAKAR UP	F1	T1	
		DAKAR EASY	F1	T1	
		Dakar	F1	T1	
		Dakar Express	F1	T1	
	BAG2	DAKAR EVO	F5	T5	
		DAKAR UP	F5	T5	
		DAKAR EASY	F5	T5	
		Dakar	F5	T5	
	BAG3	DAKAR EVO	F5	T5	
		DAKAR UP	F5	T5	
		DAKAR EASY	F5	T5	
		Dakar	F5	T5	
		Dakar Express	F5	T5	
		Dakar Express	F5	T5	
BALING LOCK®	BAK1	DAKAR EVO	F1	T1	
		DAKAR UP	F1	T1	
		DAKAR EASY	F1	T1	
		Dakar	F1	T1	
	BAK2	DAKAR EVO	F1	T1	
		DAKAR UP	F1	T1	
		DAKAR UP	F1	T1	



BALING LOCK®	BAK2	DAKAR EASY	F1	T1	
		Dakar	F1	T1	
		Dakar Express	F1	T1	
BANE®	BN11	DAKAR EVO	F1	T1	
		DAKAR UP	F1	T1	
		DAKAR EASY	F1	T1	
		Dakar	F1	T1	
		Dakar Express	F1	T1	
BASI®	BSI2R	DAKAR EVO	F1	T1	
		DAKAR UP	F1	T1	
		DAKAR EASY	F1	T1	
		Dakar	F1	T1	
		Dakar Express	F1	T1	
	BSI3	DAKAR EVO	F1	T1	
		DAKAR UP	F1	T1	
		DAKAR EASY	F1	T1	
		Dakar	F1	T1	
		Dakar Express	F1	T1	
	BSI3R	DAKAR EVO	F1	T1	
		DAKAR UP	F1	T1	
		DAKAR EASY	F1	T1	
		Dakar	F1	T1	
		Dakar Express	F1	T1	
ORIGINAL CX6	DAKAR EVO	F6	T5		
	DAKAR UP	F6	T5		
	DAKAR EASY	F6	T5		
	Dakar	F6	T5		
	Dakar Express	F6	T5		
	Dakar Express	F6	T5		
BEY®	BEY1	DAKAR EVO	F13	T13	
		DAKAR UP	F13	T13	
		DAKAR EASY	F13	T13	
		Dakar	F13	T13	
		Dakar Express	F13	T13	
	BEY2	DAKAR EVO	F19	T19	
		DAKAR UP	F19	T19	
		DAKAR EASY	F19	T19	
		Dakar	F19	T19	
		Dakar Express	F19	T19	
BILMA®	BIL1T	DAKAR EVO	F8	T8	
		DAKAR UP	F8	T8	FIC-TUB
		Dakar	F8	T8	
		Dakar Express	F8	T8	FIC-TUB
BKS®	KS50	DAKAR EVO	F26	T26	
		DAKAR UP	F26	T26	
		DAKAR EASY	F26	T26	



BKS®	KS50	Dakar	F26	T26	
		Dakar Express	F26	T26	
	ORIGINAL WS 50 NW	DAKAR EVO	F35W	T35	AD-BKS
		DAKAR UP	F35W	T35	AD-BKS
		DAKAR EASY	F35W	T35	AD-BKS
		Dakar	F35W	T35	AD-BKS
		Dakar Express	F35W	T35	AD-BKS
	ORIGINAL WS 50 RA-RK-RZ	DAKAR EVO	F35W	T35	AD-BKS
		DAKAR UP	F35W	T35	AD-BKS
		DAKAR EASY	F35W	T35	AD-BKS
		Dakar	F35W	T35	AD-BKS
		Dakar Express	F35W	T35	AD-BKS
BORKEY®	BOR1	DAKAR EVO	F1	T1	
		DAKAR UP	F1	T1	
		DAKAR EASY	F1	T1	
		Dakar	F1	T1	
		Dakar Express	F1	T1	
	BOR2	DAKAR EVO	F1	T1	
		DAKAR UP	F1	T1	
		DAKAR EASY	F1	T1	
		Dakar	F1	T1	
		Dakar Express	F1	T1	
BRAS®	BRA1	DAKAR EVO	F1	T1	
		DAKAR UP	F1	T1	
		DAKAR EASY	F1	T1	
		Dakar	F1	T1	
		Dakar Express	F1	T1	
BRICARD®	BD12R	DAKAR EVO	F1	T1	
		DAKAR UP	F1	T1	
		DAKAR EASY	F1	T1	
		Dakar	F1	T1	
		Dakar Express	F1	T1	
	BD22	DAKAR EVO	F1	T1	
		DAKAR UP	F1	T1	
		DAKAR EASY	F1	T1	
		Dakar	F1	T1	
		Dakar Express	F1	T1	
	BD23L	DAKAR EVO	F1	T1	AD-CI
		DAKAR UP	F1	T1	AD-CI
		DAKAR EASY	F1	T1	AD-CI
		Dakar	F1	T1	AD-CI
		Dakar Express	F1	T1	AD-CI



BRICARD®	BD25	DAKAR EVO	F1	T1	AD-CI
		DAKAR UP	F1	T1	AD-CI
		DAKAR EASY	F1	T1	AD-CI
		Dakar	F1	T1	AD-CI
		Dakar Express	F1	T1	AD-CI
	BD26	DAKAR EVO	F1	T1	AD-CI
		DAKAR UP	F1	T1	AD-CI
		DAKAR EASY	F1	T1	AD-CI
		Dakar	F1	T1	AD-CI
		Dakar Express	F1	T1	AD-CI
	BD27	DAKAR EVO	F1	T1	AD-CI
		DAKAR UP	F1	T1	AD-CI
		DAKAR EASY	F1	T1	AD-CI
		Dakar	F1	T1	AD-CI
		Dakar Express	F1	T1	AD-CI
	BD28	DAKAR EVO	F1	T1	AD-CI
		DAKAR UP	F1	T1	AD-CI
		DAKAR EASY	F1	T1	AD-CI
		Dakar	F1	T1	AD-CI
		Dakar Express	F1	T1	AD-CI
	BD29	DAKAR EVO	F1	T1	AD-CI
		DAKAR UP	F1	T1	AD-CI
		DAKAR EASY	F1	T1	AD-CI
		Dakar	F1	T1	AD-CI
		Dakar Express	F1	T1	AD-CI
BRISANT®	BRS1	DAKAR EVO	F19	T19	
		DAKAR UP	F19	T19	
		DAKAR EASY	F19	T19	
		Dakar	F19	T19	
		Dakar Express	F19	T19	
	BRS2	DAKAR EVO	F19	T19	
		DAKAR UP	F19	T19	
		DAKAR EASY	F19	T19	
		Dakar	F19	T19	
		Dakar Express	F19	T19	
BULAT®	BUL1	DAKAR EVO	F1	T1	
		DAKAR UP	F1	T1	
		DAKAR EASY	F1	T1	
		Dakar	F1	T1	
		Dakar Express	F1	T1	
BURG®	BG43	DAKAR EVO	F1	T1	
		DAKAR UP	F1	T1	
		DAKAR EASY	F1	T1	



BURG®	BG43	Dakar	F1	T1	
		Dakar Express	F1	T1	
	BG44	DAKAR EVO	F1	T1	
		DAKAR UP	F1	T1	
		DAKAR EASY	F1	T1	
		Dakar	F1	T1	
	BG56	Dakar Express	F1	T1	
		DAKAR EVO	F1	T1	
		DAKAR UP	F1	T1	
		DAKAR EASY	F1	T1	
	C.R.®	TT13	Dakar	F1	T1
			Dakar Express	F1	T1
			DAKAR EVO	F5	T5
			DAKAR UP	F5	T5
			DAKAR EASY	F5	T5
TT20		Dakar	F5	T5	
		Dakar Express	F5	T5	
		DAKAR EVO	F5	T5	
		DAKAR UP	F5	T5	
		DAKAR EASY	F5	T5	
TT27		Dakar	F5	T5	
		Dakar Express	F5	T5	
		DAKAR EVO	F5	T5	
		DAKAR UP	F5	T5	
		DAKAR EASY	F5	T5	
CAS-CISMA®		CIS6	Dakar	F5	T5
			Dakar Express	F5	T5
			DAKAR EVO	F5	T5
	DAKAR UP		F5	T5	
	DAKAR EASY		F5	T5	
	CIS8	Dakar	F5	T5	
		Dakar Express	F5	T5	
		DAKAR EVO	F5	T5	
		DAKAR UP	F5	T5	
		DAKAR EASY	F5	T5	
	CIS9	Dakar	F5	T5	
		Dakar Express	F5	T5	
		DAKAR EVO	F5	T5	
		DAKAR UP	F5	T5	
		DAKAR EASY	F5	T5	
	CAYS®	CAY2	DAKAR EVO	F1	T1



CAYS®	CAY2	DAKAR UP	F1	T1
		DAKAR EASY	F1	T1
		Dakar	F1	T1
		Dakar Express	F1	T1
CES®	CE42	DAKAR EVO	F32	T32
		DAKAR UP	F32	T32
		DAKAR EASY	F32	T32
		Dakar	F32	T32
	ORIGINAL WSM	Dakar Express	F32	T32
		DAKAR EVO	F32	T32
		DAKAR UP	F32	T32
		DAKAR EASY	F32	T32
		Dakar	F32	T32
		Dakar Express	F32	T32
CHICAGO®	CHI9T	DAKAR EVO	F8	T8
		DAKAR UP	F8	T8
		Dakar	F8	T8
	CHI10T	Dakar Express	F8	T8
		DAKAR EVO	F8	T8
		DAKAR UP	F8	T8
		Dakar	F8	T8
		Dakar Express	F8	T8
CHUBB®	CB7	DAKAR EVO	F1	T1
		DAKAR UP	F1	T1
		DAKAR EASY	F1	T1
		Dakar	F1	T1
		Dakar Express	F1	T1
CISA®	C21	DAKAR EVO	F1	T1
		DAKAR UP	F1	T1
		DAKAR EASY	F1	T1
		Dakar	F1	T1
		Dakar Express	F1	T1
	C24L	DAKAR EVO	F1	T1
		DAKAR UP	F1	T1
		DAKAR EASY	F1	T1
		Dakar	F1	T1
		Dakar Express	F1	T1
	C24LP	DAKAR EVO	F1	T1
		DAKAR UP	F1	T1
		DAKAR EASY	F1	T1
		Dakar	F1	T1
		Dakar Express	F1	T1
C25L	DAKAR EVO	F1	T1	



CISA®					
C25L	DAKAR UP	F1	T1	AD-CI	
	DAKAR EASY	F1	T1	AD-CI	
	Dakar	F1	T1	AD-CI	
	Dakar Express	F1	T1	AD-CI	
C25LP	DAKAR EVO	F1	T1	AD-CI	
	DAKAR UP	F1	T1	AD-CI	
	DAKAR EASY	F1	T1	AD-CI	
	Dakar	F1	T1	AD-CI	
C25T	DAKAR EVO	F1	T1	AD-CI	
	DAKAR UP	F1	T1	AD-CI	
	DAKAR EASY	F1	T1	AD-CI	
	Dakar	F1	T1	AD-CI	
C27T	DAKAR EVO	F1	T1	AD-CI	
	DAKAR UP	F1	T1	AD-CI	
	DAKAR EASY	F1	T1	AD-CI	
	Dakar	F1	T1	AD-CI	
C28L	DAKAR EVO	F1	T1	AD-CI	
	DAKAR UP	F1	T1	AD-CI	
	DAKAR EASY	F1	T1	AD-CI	
	Dakar	F1	T1	AD-CI	
C28LP	DAKAR EVO	F1	T1	AD-CI	
	DAKAR UP	F1	T1	AD-CI	
	DAKAR EASY	F1	T1	AD-CI	
	Dakar	F1	T1	AD-CI	
C33LP	DAKAR EVO	F1	T1	AD-CI	
	DAKAR UP	F1	T1	AD-CI	
	DAKAR EASY	F1	T1	AD-CI	
	Dakar	F1	T1	AD-CI	
C34L	DAKAR EVO	F1	T1	AD-CI	
	DAKAR UP	F1	T1	AD-CI	
	DAKAR EASY	F1	T1	AD-CI	
	Dakar	F1	T1	AD-CI	
C34LP	DAKAR EVO	F1	T1	AD-CI	
	DAKAR UP	F1	T1	AD-CI	
	DAKAR EASY	F1	T1	AD-CI	
	Dakar	F1	T1	AD-CI	
C40L	DAKAR EVO	F1	T1	AD-CI	
	DAKAR UP	F1	T1	AD-CI	
	DAKAR EASY	F1	T1	AD-CI	
	Dakar	F1	T1	AD-CI	



CISA®					
C40L	DAKAR UP	F1	T1	AD-CI	
	DAKAR EASY	F1	T1	AD-CI	
	Dakar	F1	T1	AD-CI	
	Dakar Express	F1	T1	AD-CI	
C40LP	DAKAR EVO	F1	T1	AD-CI	
	DAKAR UP	F1	T1	AD-CI	
	DAKAR EASY	F1	T1	AD-CI	
	Dakar	F1	T1	AD-CI	
C46LP	DAKAR EVO	F1	T1	AD-CI	
	DAKAR UP	F1	T1	AD-CI	
	DAKAR EASY	F1	T1	AD-CI	
	Dakar	F1	T1	AD-CI	
C47LP	DAKAR EVO	F1	T1	AD-CI	
	DAKAR UP	F1	T1	AD-CI	
	DAKAR EASY	F1	T1	AD-CI	
	Dakar	F1	T1	AD-CI	
C51LP	DAKAR EVO	F1	T1	AD-CI	
	DAKAR UP	F1	T1	AD-CI	
	DAKAR EASY	F1	T1	AD-CI	
	Dakar	F1	T1	AD-CI	
C52LP	DAKAR EVO	F1	T1	AD-CI	
	DAKAR UP	F1	T1	AD-CI	
	DAKAR EASY	F1	T1	AD-CI	
	Dakar	F1	T1	AD-CI	
C53	DAKAR EVO	F1	T1	AD-CI	
	DAKAR UP	F1	T1	AD-CI	
	DAKAR EASY	F1	T1	AD-CI	
	Dakar	F1	T1	AD-CI	
C57LP	DAKAR EVO	F1	T1	AD-CI	
	DAKAR UP	F1	T1	AD-CI	
	DAKAR EASY	F1	T1	AD-CI	
	Dakar	F1	T1	AD-CI	
C61	DAKAR EVO	F1	T1	AD-CI	
	DAKAR UP	F1	T1	AD-CI	
	DAKAR EASY	F1	T1	AD-CI	
	Dakar	F1	T1	AD-CI	
C62LP	DAKAR EVO	F1	T1	AD-CI	
	DAKAR UP	F1	T1	AD-CI	
	DAKAR EASY	F1	T1	AD-CI	
	Dakar	F1	T1	AD-CI	



CISA®	C62LP	DAKAR UP	F1	T1	AD-CI	
		DAKAR EASY	F1	T1	AD-CI	
		Dakar	F1	T1	AD-CI	
		Dakar Express	F1	T1	AD-CI	
CORBIN®	CO55	DAKAR EVO	F1	T1		
		DAKAR UP	F1	T1		
		DAKAR EASY	F1	T1		
		Dakar	F1	T1		
		Dakar Express	F1	T1		
	CO58	DAKAR EVO	F1	T1		
		DAKAR UP	F1	T1		
		DAKAR EASY	F1	T1		
		Dakar	F1	T1		
		Dakar Express	F1	T1		
	CVL®	CV9	DAKAR EVO	F13	T13	
			DAKAR UP	F13	T13	
DAKAR EASY			F13	T13		
Dakar			F13	T13		
Dakar Express			F13	T13		
DAF®	DF2	DAKAR EVO	F26	T26		
		DAKAR UP	F26	T26		
		DAKAR EASY	F26	T26		
		Dakar	F26	T26		
		Dakar Express	F26	T26		
	DF3	DAKAR EVO	F26	T26		
		DAKAR UP	F26	T26		
		DAKAR EASY	F26	T26		
		Dakar	F26	T26		
		Dakar Express	F26	T26		
	DF4R	DAKAR EVO	F26	T26		
		DAKAR UP	F26	T26		
		DAKAR EASY	F26	T26		
		Dakar	F26	T26		
		Dakar Express	F26	T26		
DEKABA®	DKB1	DAKAR EVO	F1	T1		
		DAKAR UP	F1	T1		
		DAKAR EASY	F1	T1		
		Dakar	F1	T1		
		Dakar Express	F1	T1		
	DKB8	DAKAR EVO	F1	T1		
		DAKAR UP	F1	T1		
		DAKAR EASY	F1	T1		
		Dakar	F1	T1		
		Dakar Express	F1	T1		
DKB10	DAKAR EVO	F1	T1			



DEKABA®	DKB10	DAKAR UP	F1	T1	
		DAKAR EASY	F1	T1	
		Dakar	F1	T1	
		Dakar Express	F1	T1	
	DKB11	DAKAR EVO	F1	T1	
		DAKAR UP	F1	T1	
		DAKAR EASY	F1	T1	
		Dakar	F1	T1	
		Dakar Express	F1	T1	
	DKB12	DAKAR EVO	F1	T1	
		DAKAR UP	F1	T1	
		DAKAR EASY	F1	T1	
Dakar		F1	T1		
Dakar Express		F1	T1		
DELCA®	DLC1	DAKAR EVO	F1	T1	
		DAKAR UP	F1	T1	
		DAKAR EASY	F1	T1	
		Dakar	F1	T1	
		Dakar Express	F1	T1	
	DLC1R	DAKAR EVO	F1	T1	
		DAKAR UP	F1	T1	
		DAKAR EASY	F1	T1	
		Dakar	F1	T1	
		Dakar Express	F1	T1	
	DLC2R	DAKAR EVO	F1	T1	
		DAKAR UP	F1	T1	
		DAKAR EASY	F1	T1	
		Dakar	F1	T1	
		Dakar Express	F1	T1	
	DLC3	DAKAR EVO	F1	T1	
		DAKAR UP	F1	T1	
		DAKAR EASY	F1	T1	
Dakar		F1	T1		
Dakar Express		F1	T1		
DLC3R	DAKAR EVO	F1	T1		
	DAKAR UP	F1	T1		
	DAKAR EASY	F1	T1		
	Dakar	F1	T1		
	Dakar Express	F1	T1		
DLC4	DAKAR EVO	F1	T1		
	DAKAR UP	F1	T1		
	DAKAR EASY	F1	T1		
	Dakar	F1	T1		
	Dakar Express	F1	T1		
DELTA®	DLT1R	DAKAR EVO	F5	T5	



FOR:	CERRERI	Profile	Disc	Key	Lock		
DELTA®	DLT1R	DAKAR UP	F5	T5			
		DAKAR EASY	F5	T5			
		Dakar	F5	T5			
		Dakar Express	F5	T5			
DIAMOND®	DI2	DAKAR EVO	F19	T19			
		DAKAR UP	F19	T19			
		DAKAR EASY	F19	T19			
		Dakar	F19	T19			
		Dakar Express	F19	T19			
	DI3	DAKAR EVO	F19	T19			
		DAKAR UP	F19	T19			
		DAKAR EASY	F19	T19			
		Dakar	F19	T19			
		Dakar Express	F19	T19			
		DIERRE®	DR2	DAKAR EVO	F13	T13	
				DAKAR UP	F13	T13	
DAKAR EASY	F13			T13			
Dakar	F13			T13			
DOM®	DM102	DAKAR EVO	F1A	T23	AD-DM		
		DAKAR UP	F1A	T23	AD-DM		
		DAKAR EASY	F1A	T23	AD-DM		
		Dakar	F1A	T23	AD-DM		
		Dakar Express	F1A	T23	AD-DM		
	DM106	DAKAR EVO	F1	T1			
		DAKAR UP	F1	T1			
		DAKAR EASY	F1	T1			
		Dakar	F1	T1			
	DM107	DAKAR EVO	F1	T1	AD-ST5		
		DAKAR UP	F1	T1	AD-ST5		
		DAKAR EASY	F1	T1	AD-ST5		
		Dakar	F1	T1	AD-ST5		
	DM27	DAKAR EVO	F1	T1			
		DAKAR UP	F1	T1			
		DAKAR EASY	F1	T1			
		Dakar	F1	T1			
	DM37L	DAKAR EVO	F1	T1	AD-ST5		
		DAKAR UP	F1	T1	AD-ST5		
		DAKAR EASY	F1	T1	AD-ST5		
		Dakar	F1	T1	AD-ST5		



FOR:	CERRERI	Profile	Disc	Key	Lock
DOM®	DM37L	Dakar Express	F1	T1	AD-ST5
		DAKAR EVO	F1	T1	
	DM38L	DAKAR UP	F1	T1	
		DAKAR EASY	F1	T1	
		Dakar	F1	T1	
		Dakar Express	F1	T1	
	DM39L	DAKAR EVO	F1	T1	
		DAKAR UP	F1	T1	
		DAKAR EASY	F1	T1	
		Dakar	F1	T1	
	DM46	DAKAR EVO	F1	T1	
		DAKAR UP	F1	T1	
		DAKAR EASY	F1	T1	
		Dakar	F1	T1	
	DM60L	DAKAR EVO	F1	T1	
		DAKAR UP	F1	T1	
		DAKAR EASY	F1	T1	
		Dakar	F1	T1	
	DM75L	DAKAR EVO	F1	T1	
		DAKAR UP	F1	T1	
		DAKAR EASY	F1	T1	
		Dakar	F1	T1	
	DM75LB	DAKAR EVO	F1	T1	
		DAKAR UP	F1	T1	
		DAKAR EASY	F1	T1	
		Dakar	F1	T1	
	DM76	DAKAR EVO	F1	T1	AD-ST5
		DAKAR UP	F1	T1	AD-ST5
		DAKAR EASY	F1	T1	AD-ST5
		Dakar	F1	T1	AD-ST5
	DM77	DAKAR EVO	F1	T1	AD-ST5
		DAKAR UP	F1	T1	AD-ST5
		DAKAR EASY	F1	T1	AD-ST5
		Dakar	F1	T1	AD-ST5
	DM82L	DAKAR EVO	F1	T1	
		DAKAR UP	F1	T1	
		DAKAR EASY	F1	T1	
		Dakar	F1	T1	

FOR:



DOM®					
DM82L	Dakar	F1	T1		
	Dakar Express	F1	T1		
DM83	DAKAR EVO	F1	T1	AD-ST5	
DM83	DAKAR UP	F1	T1	AD-ST5	
	DAKAR EASY	F1	T1	AD-ST5	
	Dakar	F1	T1	AD-ST5	
	Dakar Express	F1	T1	AD-ST5	
DM83L	DAKAR EVO	F1	T1	AD-ST5	
	DAKAR UP	F1	T1	AD-ST5	
	DAKAR EASY	F1	T1	AD-ST5	
	Dakar	F1	T1	AD-ST5	
	Dakar Express	F1	T1	AD-ST5	
	DAKAR EVO	F1A	T23	AD-DM	
	DAKAR UP	F1A	T23	AD-DM	
	DAKAR EASY	F1A	T23	AD-DM	
DM102	Dakar	F1A	T23	AD-DM	
	Dakar Express	F1A	T23	AD-DM	
	DAKAR EVO	F1	T1		
	DAKAR UP	F1	T1		
DM106	DAKAR EASY	F1	T1		
	Dakar	F1	T1		
	Dakar Express	F1	T1		
	DAKAR EVO	F1	T1	AD-ST5	
DM107	DAKAR UP	F1	T1	AD-ST5	
	DAKAR EASY	F1	T1	AD-ST5	
	Dakar	F1	T1	AD-ST5	
	Dakar Express	F1	T1	AD-ST5	
	DAKAR EVO	F23	T23		
ORIGINAL IX DAS 138	DAKAR UP	F23	T23		
	DAKAR EASY	F23	T23		
	Dakar	F23	T23		
	Dakar Express	F23	T23		
ORIGINAL IX5 DAS 038	DAKAR EVO	F1	T1	AD-DO	
	DAKAR UP	F1	T1	AD-DO	
	DAKAR EASY	F1	T1	AD-DO	
	Dakar	F1	T1	AD-DO	
	Dakar Express	F1	T1	AD-DO	
	DAKAR EVO	F1A	T1	AD-DO	
	DAKAR UP	F1A	T1	AD-DO	
	DAKAR EASY	F1A	T1	AD-DO	
ORIGINAL IX6 KG 102/121	Dakar	F1A	T1	AD-DO	
	Dakar Express	F1A	T1	AD-DO	
	DAKAR EVO	F23	T23	AD-DO	
	DAKAR EVO	F23	T23	AD-DO	

FOR:



DOM®						
ORIGINAL IX6 SR 132/232	DAKAR UP	F23	T23	AD-DO		
	DAKAR EASY	F23	T23	AD-DO		
	Dakar	F23	T23	AD-DO		
	Dakar Express	F23	T23	AD-DO		
DOMUS®	DO6	DAKAR EVO	F1	T1		
		DAKAR UP	F1	T1		
		DAKAR EASY	F1	T1		
		Dakar	F1	T1		
		Dakar Express	F1	T1		
		DAKAR EVO	F1	T1		
		DAKAR UP	F1	T1		
		DAKAR EASY	F1	T1		
	DO7	Dakar	F1	T1		
		Dakar Express	F1	T1		
DAKAR EVO		F1	T1			
DAKAR UP		F1	T1			
	DAKAR EASY	F1	T1			
	Dakar	F1	T1			
	Dakar Express	F1	T1			
	DAKAR EVO	F5	T5			
ELZETT®	EZ12	DAKAR UP	F5	T5		
		DAKAR EASY	F5	T5		
		Dakar	F5	T5		
		Dakar Express	F5	T5		
	EZ12R	DAKAR EVO	F5	T5		
		DAKAR UP	F5	T5		
		DAKAR EASY	F5	T5		
		Dakar	F5	T5		
		Dakar Express	F5	T5		
		DAKAR EVO	F1	T1		
DAKAR UP		F1	T1			
DAKAR EASY		F1	T1			
EZ14	Dakar	F1	T1			
	Dakar Express	F1	T1			
	DAKAR EVO	F1	T1			
	DAKAR UP	F1	T1			
	DAKAR EASY	F1	T1			
	Dakar	F1	T1			
	Dakar Express	F1	T1			
	DAKAR EVO	F1	T1			
EZ15	DAKAR UP	F1	T1			
	DAKAR EASY	F1	T1			
	Dakar	F1	T1			
	Dakar Express	F1	T1			
EZ18	DAKAR EVO	F26	T26			
	DAKAR UP	F26	T26			
	DAKAR EASY	F26	T26			
	Dakar	F26	T26			
	Dakar Express	F26	T26			
	DAKAR EVO	BF3N	T3			
	DAKAR UP	BF3N	T3			
	DAKAR EASY	BF3N	T3			
EUROLOCKS®	Dakar	BF3N	T3			



EUROLOCKS®	EL11	Dakar Express	BF3N	T3
	EL16P180	DAKAR EVO	BF3N	T3
		DAKAR UP	BF3N	T3
		DAKAR EASY	BF3N	T3
		Dakar	BF3N	T3
		Dakar Express	BF3N	T3
	EL17RP180	DAKAR EVO	BF3N	T3
		DAKAR UP	BF3N	T3
		DAKAR EASY	BF3N	T3
		Dakar	BF3N	T3
		Dakar Express	BF3N	T3
EVVA®	EV24	DAKAR EVO	F1	T1
		DAKAR UP	F1	T1
		DAKAR EASY	F1	T1
		Dakar	F1	T1
		Dakar Express	F1	T1
EZCURRA®	ECU6	DAKAR EVO	F1	T1
			F16	T16
		DAKAR UP	F1	T1
			F16	T16
		DAKAR EASY	F1	T1
			F16	T16
		Dakar	F1	T1
			F16	T16
		Dakar Express	F1	T1
			F16	T16
	ECU7	DAKAR EVO	F1	T1
			F16	T16
		DAKAR UP	F1	T1
			F16	T16
		DAKAR EASY	F1	T1
			F16	T16
		Dakar	F1	T1
			F16	T16
		Dakar Express	F1	T1
			F16	T16
	ECU8	DAKAR EVO	F1	T1
			F16	T16
		DAKAR UP	F1	T1
			F16	T16
		DAKAR EASY	F1	T1
			F16	T16
		Dakar	F1	T1
			F16	T16
		Dakar Express	F1	T1







EZCURRA®	ECU8	Dakar Express	F16	T16
	ECU9	DAKAR EVO	F1	T1
			F16	T16
		DAKAR UP	F1	T1
			F16	T16
		DAKAR EASY	F1	T1
			F16	T16
		Dakar	F1	T1
			F16	T16
		Dakar Express	F1	T1
			F16	T16
FAC®	FAC19	DAKAR EVO	F1	T1
		DAKAR UP	F1	T1
		DAKAR EASY	F1	T1
		Dakar	F1	T1
		Dakar Express	F1	T1
	FAC23	DAKAR EVO	F1	T1
		DAKAR UP	F1	T1
		DAKAR EASY	F1	T1
		Dakar	F1	T1
		Dakar Express	F1	T1
	FAC24	DAKAR EVO	F1	T1
		DAKAR UP	F1	T1
		DAKAR EASY	F1	T1
		Dakar	F1	T1
		Dakar Express	F1	T1
	FAC25	DAKAR EVO	F1	T1
		DAKAR UP	F1	T1
		DAKAR EASY	F1	T1
		Dakar	F1	T1
		Dakar Express	F1	T1
FACCHINETTI®	FF21	DAKAR EVO	F13	T13
		DAKAR UP	F13	T13
		DAKAR EASY	F13	T13
		Dakar	F13	T13
		Dakar Express	F13	T13
FAVOUR®	FAV1R	DAKAR EVO	F26	T26
		DAKAR UP	F26	T26
		DAKAR EASY	F26	T26
		Dakar	F26	T26
		Dakar Express	F26	T26
	FAV2	DAKAR EVO	F26	T26
		DAKAR UP	F26	T26
		DAKAR EASY	F26	T26
		Dakar	F26	T26







FAVOUR®	FAV2	Dakar Express	F26	T26		
FAYN®	FAY2R	DAKAR EVO	F5	T5		
		DAKAR UP	F5	T5		
		DAKAR EASY	F5	T5		
		Dakar	F5	T5		
		Dakar Express	F5	T5		
FIAM®	FM3R	DAKAR EVO	F26	T26		
		DAKAR UP	F26	T26		
		DAKAR EASY	F26	T26		
		Dakar	F26	T26		
		Dakar Express	F26	T26		
	FM4	DAKAR EVO	F26	T26		
		DAKAR UP	F26	T26		
		DAKAR EASY	F26	T26		
		Dakar	F26	T26		
		Dakar Express	F26	T26		
FICHET®	FC6	DAKAR EVO	BF3-3T	T3	AD-2H	
		DAKAR UP	BF3-3T	T3	FIC-TUB	
		Dakar	BF3-3T	T3	AD-2H	
		Dakar Express	BF3-3T	T3	FIC-TUB	
	FC11	DAKAR EVO	BF3-3T	T3	AD-2H	
		DAKAR UP	BF3-3T	T3	FIC-TUB	
		Dakar	BF3-3T	T3	AD-2H	
		Dakar Express	BF3-3T	T3		
	FC14	DAKAR EVO	F18	T18		
		Dakar	F18	T18	FIC-18	
	FONTANE-PROGRESS®	PF1	DAKAR EVO	F8	T8	
			DAKAR UP	F8	T8	FIC-TUB
Dakar			F8	T8		
Dakar Express			F8	T8	FIC-TUB	
PF1F4L		DAKAR EVO	F8	T8		
		DAKAR UP	F8	T8	FIC-TUB	
		Dakar	F8	T8		
		Dakar Express	F8	T8	FIC-TUB	
PF1F6		DAKAR EVO	F8	T8		
		DAKAR UP	F8	T8	FIC-TUB	
		Dakar	F8	T8		
		Dakar Express	F8	T8	FIC-TUB	
FTH®	FT10	DAKAR EVO	F5	T5		
		DAKAR UP	F5	T5		
		DAKAR EASY	F5	T5		
		Dakar	F5	T5		
		Dakar Express	F5	T5		



FTH®	FT20	DAKAR EVO	F5	T5	
		DAKAR UP	F5	T5	
	FT20	DAKAR EASY	F5	T5	
		Dakar	F5	T5	
		Dakar Express	F5	T5	
	FT22	DAKAR EVO	F5	T5	
		DAKAR UP	F5	T5	
		DAKAR EASY	F5	T5	
		Dakar	F5	T5	
		Dakar Express	F5	T5	
	FT25	DAKAR EVO	F5	T5	
		DAKAR UP	F5	T5	
		DAKAR EASY	F5	T5	
		Dakar	F5	T5	
		Dakar Express	F5	T5	
	FT26R	DAKAR EVO	F5	T5	
		DAKAR UP	F5	T5	
		DAKAR EASY	F5	T5	
		Dakar	F5	T5	
		Dakar Express	F5	T5	
	FT27	DAKAR EVO	F5	T5	
		DAKAR UP	F5	T5	
		DAKAR EASY	F5	T5	
		Dakar	F5	T5	
		Dakar Express	F5	T5	
	FT29	DAKAR EVO	F5	T5	
		DAKAR UP	F5	T5	
DAKAR EASY		F5	T5		
Dakar		F5	T5		
Dakar Express		F5	T5		
FUARO®	FUA1R	DAKAR EVO	F5	T5	
		DAKAR UP	F5	T5	
		DAKAR EASY	F5	T5	
		Dakar	F5	T5	
		Dakar Express	F5	T5	
G.M.®	T00GM37P	DAKAR EVO	F11	T11	
		DAKAR UP	F11	T11	
		DAKAR EASY	F11	T11	
		Dakar	F11	T11	
		Dakar Express	F11	T11	
GERA®	ORIGINAL GERA WS / WS XP / PLUS	DAKAR EVO	F13	T13	
		DAKAR UP	F13	T13	

FOR:					
GERA®	ORIGINAL GERA WS / WS XP / PLUS	DAKAR EASY	F13	T13	
	Dakar		F13	T13	
	Dakar Express		F13	T13	
GERDA®	GDA1P164	DAKAR EVO	F1	T1	
		DAKAR UP	F1	T1	
		DAKAR EASY	F1	T1	
		Dakar	F1	T1	
		Dakar Express	F1	T1	
GEVY®	GEV1	DAKAR EVO	F1	T1	
		DAKAR UP	F1	T1	
		DAKAR EASY	F1	T1	
		Dakar	F1	T1	
		Dakar Express	F1	T1	
GIOBERT-TRW-SIPEA®	GB6P113	DAKAR EVO	F6	T6	
		DAKAR UP	F6	T6	
		DAKAR EASY	F6	T6	
		Dakar	F6	T6	
		Dakar Express	F6	T6	
	GB18C1	DAKAR EVO	BF3-3T	BT3	
		DAKAR UP	BF3-3T	BT3	
		DAKAR EASY	BF3-3T	BT3	
		Dakar	BF3-3T	BT3	
		Dakar Express	BF3-3T	BT3	
	GB18P	DAKAR EVO	BF3-3T	BT3	
		DAKAR UP	BF3-3T	BT3	
		DAKAR EASY	BF3-3T	BT3	
		Dakar	BF3-3T	BT3	
		Dakar Express	BF3-3T	BT3	
	GB18P174	DAKAR EVO	BF3-3T	BT3	
		DAKAR UP	BF3-3T	BT3	
		DAKAR EASY	BF3-3T	BT3	
		Dakar	BF3-3T	BT3	
		Dakar Express	BF3-3T	BT3	
	T00GB17RPA	DAKAR EVO	BF3-3T	BT3	
		DAKAR UP	BF3-3T	BT3	
		DAKAR EASY	BF3-3T	BT3	
		Dakar	BF3-3T	BT3	
		Dakar Express	BF3-3T	BT3	
	T00GB17RPB	DAKAR EVO	BF3-3T	BT3	
		DAKAR UP	BF3-3T	BT3	
DAKAR EASY		BF3-3T	BT3		
Dakar		BF3-3T	BT3		
Dakar Express		BF3-3T	BT3		

FOR:					
GIOBERT-TRW-SIPEA®	T00GB18P	DAKAR EVO	BF3-3T	BT3	
		DAKAR UP	BF3-3T	BT3	
		DAKAR EASY	BF3-3T	BT3	
		Dakar	BF3-3T	BT3	
		Dakar Express	BF3-3T	BT3	
	T00GB18PN	DAKAR EVO	BF3-3T	BT3	
		DAKAR UP	BF3-3T	BT3	
		DAKAR EASY	BF3-3T	BT3	
		Dakar	BF3-3T	BT3	
		Dakar Express	BF3-3T	BT3	
GIUSSANI®	GU12	DAKAR EVO	BF3-3T	BT3	
		DAKAR UP	BF3-3T	BT3	
		DAKAR EASY	BF3-3T	BT3	
		Dakar	BF3-3T	BT3	
		Dakar Express	BF3-3T	BT3	
HB®	HBO1	DAKAR EVO	F13	T13	
		DAKAR UP	F13	T13	
		DAKAR EASY	F13	T13	
		Dakar	F13	T13	
		Dakar Express	F13	T13	
HOK®	HOK1	DAKAR EVO	F5	T5	
		DAKAR UP	F5	T5	
		DAKAR EASY	F5	T5	
		Dakar	F5	T5	
		Dakar Express	F5	T5	
HONDA®	HD44P93	DAKAR EVO	F17	T17	
		DAKAR UP	F17	T17	
		DAKAR EASY	F17	T17	
		Dakar	F17	T17	
		Dakar Express	F17	T17	
	HD58P	DAKAR EVO	F17	T17	
		DAKAR UP	F17	T17	
		DAKAR EASY	F17	T17	
		Dakar	F17	T17	
		Dakar Express	F17	T17	
	T00HD58P	DAKAR EVO	F17	T17	
		DAKAR UP	F17	T17	
		DAKAR EASY	F17	T17	
		Dakar	F17	T17	
		Dakar Express	F17	T17	
	T00HD62P	DAKAR EVO	F17	T17	
		DAKAR UP	F17	T17	
		DAKAR EASY	F17	T17	
		Dakar	F17	T17	
		Dakar Express	F17	T17	



HONDA®	T00HD62P	Dakar Express	F17	T17	
		DAKAR EVO	F17	T17	
		DAKAR UP	F17	T17	
		DAKAR EASY	F17	T17	
		Dakar	F17	T17	
		Dakar Express	F17	T17	
HTEC®	HTE1	DAKAR EVO	F5	T5	
		DAKAR UP	F5	T5	
		DAKAR EASY	F5	T5	
		Dakar	F5	T5	
		Dakar Express	F5	T5	
HUF®	HF38AP18	DAKAR EVO	F11	T11	AD-MM
		DAKAR UP	F11	T11	AD-MM
		DAKAR EASY	F11	T11	AD-MM
		Dakar	F11	T11	AD-MM
		Dakar Express	F11	T11	AD-MM
	HF38P17	DAKAR EVO	F11	T11	AD-MM
		DAKAR UP	F11	T11	AD-MM
		DAKAR EASY	F11	T11	AD-MM
		Dakar	F11	T11	AD-MM
		Dakar Express	F11	T11	AD-MM
	HF39P17	DAKAR EVO	F11	T11	AD-MJ
		DAKAR UP	F11	T11	AD-MJ
		DAKAR EASY	F11	T11	AD-MJ
		Dakar	F11	T11	AD-MJ
		Dakar Express	F11	T11	AD-MJ
	HF40P18	DAKAR EVO	F11	T11	AD-MJ
		DAKAR UP	F11	T11	AD-MJ
		DAKAR EASY	F11	T11	AD-MJ
		Dakar	F11	T11	AD-MJ
		Dakar Express	F11	T11	AD-MJ
	HF42C1	DAKAR EVO	F17	T17	AD-OP
		DAKAR UP	F17	T17	AD-OP
		DAKAR EASY	F17	T17	AD-OP
		Dakar	F17	T17	AD-OP
		Dakar Express	F17	T17	AD-OP
	HF42P15	DAKAR EVO	F17	T17	AD-OP
		DAKAR UP	F17	T17	AD-OP
		DAKAR EASY	F17	T17	AD-OP
		Dakar	F17	T17	AD-OP
		Dakar Express	F17	T17	AD-OP
	HF48P8	DAKAR EVO	F11	T11	AD-MJ
		DAKAR UP	F11	T11	AD-MJ
		DAKAR EASY	F11	T11	AD-MJ



HUF®	HF48P8	Dakar	F11	T11	AD-MJ
		Dakar Express	F11	T11	AD-MJ
HF49P62	DAKAR EVO	DAKAR UP	F11	T11	AD-VO
		DAKAR EASY	F11	T11	AD-VO
		Dakar	F11	T11	AD-VO
		Dakar Express	F11	T11	AD-VO
		DAKAR EVO	F11	T11	AD-MM
HF51P17	DAKAR UP	DAKAR EASY	F11	T11	AD-MM
		Dakar	F11	T11	AD-MM
		Dakar Express	F11	T11	AD-MM
		DAKAR EVO	F11	T11	AD-MM
		DAKAR UP	F11	T11	AD-MM
HF52P18	DAKAR EASY	Dakar	F11	T11	AD-MM
		Dakar Express	F11	T11	AD-MM
		DAKAR EVO	F11	T11	AD-MM
		DAKAR UP	F11	T11	AD-MM
		DAKAR EASY	F11	T11	AD-MM
HF53P17	Dakar	Dakar Express	F11	T11	AD-MM
		DAKAR EVO	F11	T11	AD-MM
		DAKAR UP	F11	T11	AD-MM
		DAKAR EASY	F11	T11	AD-MM
		Dakar	F11	T11	AD-MM
HF55C1	DAKAR EVO	DAKAR UP	F11	T11	AD-MA
		DAKAR EASY	F11	T11	AD-MA
		Dakar	F11	T11	AD-MA
		Dakar Express	F11	T11	AD-MA
		DAKAR EVO	F11	T11	AD-MA
HF55C2	DAKAR UP	DAKAR EASY	F11	T11	AD-MA
		Dakar	F11	T11	AD-MA
		Dakar Express	F11	T11	AD-MA
		DAKAR EVO	F11	T11	AD-MA
		DAKAR UP	F11	T11	AD-MA
HF55C3	DAKAR EASY	Dakar	F11	T11	AD-MA
		Dakar Express	F11	T11	AD-MA
		DAKAR EVO	F11	T11	AD-MA
		DAKAR UP	F11	T11	AD-MA
		DAKAR EASY	F11	T11	AD-MA
HF55C4	Dakar	Dakar Express	F11	T11	AD-MA
		DAKAR EVO	F11	T11	AD-MA
		DAKAR UP	F11	T11	AD-MA
		DAKAR EASY	F11	T11	AD-MA
		Dakar	F11	T11	AD-MA
HF55C5	DAKAR EVO	DAKAR UP	F11	T11	AD-MA
		DAKAR EASY	F11	T11	AD-MA



HUF®					
HF55C5	DAKAR UP	F11	T11	AD-MA	
	DAKAR EASY	F11	T11	AD-MA	
	Dakar	F11	T11	AD-MA	
	Dakar Express	F11	T11	AD-MA	
HF55P65	DAKAR EVO	F11	T11	AD-MA	
	DAKAR UP	F11	T11	AD-MA	
	DAKAR EASY	F11	T11	AD-MA	
	Dakar	F11	T11	AD-MA	
HF57	DAKAR EVO	F11	T11	AD-MJ	
	DAKAR UP	F11	T11	AD-MJ	
	DAKAR EASY	F11	T11	AD-MJ	
	Dakar	F11	T11	AD-MJ	
HF59P150	DAKAR EVO	F11	T11		
	DAKAR UP	F11	T11		
	DAKAR EASY	F11	T11		
	Dakar	F11	T11		
HF63P	DAKAR EVO	F11	T11		
	DAKAR UP	F11	T11		
	DAKAR EASY	F11	T11		
	Dakar	F11	T11		
HF65C1	DAKAR EVO	F17	T17		
	DAKAR UP	F17	T17	AD-FD1	
	DAKAR EASY	F17	T17	AD-FD1	
	Dakar	F17	T17		
HF65C2	DAKAR EVO	F17	T17		
	DAKAR UP	F17	T17	AD-FD1	
	DAKAR EASY	F17	T17	AD-FD1	
	Dakar	F17	T17		
HF65C3	DAKAR EVO	F17	T17		
	DAKAR UP	F17	T17	AD-FD1	
	DAKAR EASY	F17	T17	AD-FD1	
	Dakar	F17	T17		
HF65P	DAKAR EVO	F17	T17		
	DAKAR UP	F17	T17	AD-FD1	
	DAKAR EASY	F17	T17	AD-FD1	
	Dakar	F17	T17		
HF66C1	DAKAR EVO	F17	T17		



HUF®					
HF66C1	DAKAR UP	F17	T17		
	DAKAR EASY	F17	T17		
	Dakar	F17	T17		
	Dakar Express	F17	T17		
HF66C3	DAKAR EVO	F17	T17		
	DAKAR UP	F17	T17		
	DAKAR EASY	F17	T17		
	Dakar	F17	T17		
HF66P	DAKAR EVO	F17	T17		
	DAKAR UP	F17	T17		
	DAKAR EASY	F17	T17		
	Dakar	F17	T17		
HF70P	DAKAR EVO	F11	T11	AD-MA	
	DAKAR UP	F11	T11	AD-MA	
	DAKAR EASY	F11	T11	AD-MA	
	Dakar	F11	T11	AD-MA	
HF70P171	DAKAR EVO	F11	T11	AD-MA	
	DAKAR UP	F11	T11	AD-MA	
	DAKAR EASY	F11	T11	AD-MA	
	Dakar	F11	T11	AD-MA	
HF73C1	DAKAR EVO	F3	T3		
	DAKAR UP	F3	T3		
	DAKAR EASY	F3	T3		
	Dakar	F3	T3		
HF74C1	DAKAR EVO	F3	T3		
	DAKAR UP	F3	T3		
	DAKAR EASY	F3	T3		
	Dakar	F3	T3		
HF75C1	DAKAR EVO	F3	T3		
	DAKAR UP	F3	T3		
	DAKAR EASY	F3	T3		
	Dakar	F3	T3		
T00HF38P	DAKAR EVO	F11	T11	AD-MM	
	DAKAR UP	F11	T11	AD-MM	
	DAKAR EASY	F11	T11	AD-MM	
	Dakar	F11	T11	AD-MM	
T00HF42P	DAKAR EVO	F17	T17	AD-OP	

FOR:



HUF®

T00HF42P	DAKAR UP	F17	T17	AD-OP
	DAKAR EASY	F17	T17	AD-OP
	Dakar	F17	T17	AD-OP
	Dakar Express	F17	T17	AD-OP
T00HF42PA	DAKAR EVO	F17	T17	AD-OP
	DAKAR UP	F17	T17	AD-OP
	DAKAR EASY	F17	T17	AD-OP
	Dakar	F17	T17	AD-OP
T00HF42PB	DAKAR EVO	F17	T17	AD-OP
	DAKAR UP	F17	T17	AD-OP
	DAKAR EASY	F17	T17	AD-OP
	Dakar	F17	T17	AD-OP
T00HF48P	DAKAR EVO	F11	T11	AD-MJ
	DAKAR UP	F11	T11	AD-MJ
	DAKAR EASY	F11	T11	AD-MJ
	Dakar	F11	T11	AD-MJ
T00HF49P	DAKAR EVO	F11	T11	AD-VO
	DAKAR UP	F11	T11	AD-VO
	DAKAR EASY	F11	T11	AD-VO
	Dakar	F11	T11	AD-VO
T00HF49PA	DAKAR EVO	F11	T11	AD-VO
	DAKAR UP	F11	T11	AD-VO
	DAKAR EASY	F11	T11	AD-VO
	Dakar	F11	T11	AD-VO
T00HF49PB	DAKAR EVO	F11	T11	AD-VO
	DAKAR UP	F11	T11	AD-VO
	DAKAR EASY	F11	T11	AD-VO
	Dakar	F11	T11	AD-VO
T00HF51P	DAKAR EVO	F11	T11	AD-MM
	DAKAR UP	F11	T11	AD-MM
	DAKAR EASY	F11	T11	AD-MM
	Dakar	F11	T11	AD-MM
T00HF55P	DAKAR EVO	F11	T11	AD-MA
	DAKAR UP	F11	T11	AD-MA
	DAKAR EASY	F11	T11	AD-MA
	Dakar	F11	T11	AD-MA
T00HF55PA	DAKAR EVO	F11	T11	AD-MA
	DAKAR UP	F11	T11	AD-MA
	DAKAR EASY	F11	T11	AD-MA
	Dakar	F11	T11	AD-MA
T00HF55PB	DAKAR EVO	F11	T11	AD-MA
	DAKAR UP	F11	T11	AD-MA
	DAKAR EASY	F11	T11	AD-MA
	Dakar	F11	T11	AD-MA

FOR:



HUF®

T00HF55PB	DAKAR UP	F11	T11	AD-MA
	DAKAR EASY	F11	T11	AD-MA
	Dakar	F11	T11	AD-MA
	Dakar Express	F11	T11	AD-MA
T00HF55PT1	DAKAR EVO	F11	T11	AD-MA
	DAKAR UP	F11	T11	AD-MA
	DAKAR EASY	F11	T11	AD-MA
	Dakar	F11	T11	AD-MA
T00HF55PT2	DAKAR EVO	F11	T11	AD-MA
	DAKAR UP	F11	T11	AD-MA
	DAKAR EASY	F11	T11	AD-MA
	Dakar	F11	T11	AD-MA
T00HF63P	DAKAR EVO	F11	T11	
	DAKAR UP	F11	T11	
	DAKAR EASY	F11	T11	
	Dakar	F11	T11	
T00HF65P	DAKAR EVO	F17	T17	
	DAKAR UP	F17	T17	AD-FD1
	DAKAR EASY	F17	T17	AD-FD1
	Dakar	F17	T17	
T00HF65PA	DAKAR EVO	F17	T17	
	DAKAR UP	F17	T17	AD-FD1
	DAKAR EASY	F17	T17	AD-FD1
	Dakar	F17	T17	
T00HF65PB	DAKAR EVO	F17	T17	
	DAKAR UP	F17	T17	AD-FD1
	DAKAR EASY	F17	T17	AD-FD1
	Dakar	F17	T17	
T00HF65PC	DAKAR EVO	F17	T17	
	DAKAR UP	F17	T17	AD-FD1
	DAKAR EASY	F17	T17	AD-FD1
	Dakar	F17	T17	
T00HF66P	DAKAR EVO	F17	T17	
	DAKAR UP	F17	T17	
	DAKAR EASY	F17	T17	
	Dakar	F17	T17	
T00HF66PB	DAKAR EVO	F17	T17	
	DAKAR UP	F17	T17	
	DAKAR EASY	F17	T17	
	Dakar	F17	T17	



HUF®				
T00HF66PB	DAKAR UP	F17	T17	
	DAKAR EASY	F17	T17	
	Dakar	F17	T17	
	Dakar Express	F17	T17	
T00HF66PC	DAKAR EVO	F17	T17	
	DAKAR UP	F17	T17	
	DAKAR EASY	F17	T17	
	Dakar	F17	T17	
T00HF66PD	DAKAR EVO	F17	T17	
	DAKAR UP	F17	T17	
	DAKAR EASY	F17	T17	
	Dakar	F17	T17	
T00HF66PE	DAKAR EVO	F17	T17	
	DAKAR UP	F17	T17	
	DAKAR EASY	F17	T17	
	Dakar	F17	T17	
T00HF70P	DAKAR EVO	F11	T11	AD-MA
	DAKAR UP	F11	T11	AD-MA
	DAKAR EASY	F11	T11	AD-MA
	Dakar	F11	T11	AD-MA
T00HF70PA	DAKAR EVO	F11	T11	AD-MA
	DAKAR UP	F11	T11	AD-MA
	DAKAR EASY	F11	T11	AD-MA
	Dakar	F11	T11	AD-MA
T00HF70PBT	DAKAR EVO	F11	T11	AD-MA
	DAKAR UP	F11	T11	AD-MA
	DAKAR EASY	F11	T11	AD-MA
	Dakar	F11	T11	AD-MA
T00HF70PT	DAKAR EVO	F11	T11	AD-MA
	DAKAR UP	F11	T11	AD-MA
	DAKAR EASY	F11	T11	AD-MA
	Dakar	F11	T11	AD-MA
T00HF71P	DAKAR EVO	BF3N	T3	
	DAKAR UP	BF3N	T3	
	DAKAR EASY	BF3N	T3	
	Dakar	BF3N	T3	
T00HF72P	DAKAR EVO	F11	T11	
	DAKAR UP	F11	T11	
	DAKAR EASY	F11	T11	
	Dakar	F11	T11	



HUF®				
T00HF72P	DAKAR UP	F11	T11	
	DAKAR EASY	F11	T11	
	Dakar	F11	T11	
	Dakar Express	F11	T11	
T00HF74C1	DAKAR EVO	F3	T3	
	DAKAR UP	F3	T3	
	DAKAR EASY	F3	T3	
	Dakar	F3	T3	
T00HF75C1	DAKAR EVO	F3	T3	
	DAKAR UP	F3	T3	
	DAKAR EASY	F3	T3	
	Dakar	F3	T3	
HUGO®	DAKAR EVO	F5	T5	
	DAKAR UP	F5	T5	
	DAKAR EASY	F5	T5	
	Dakar	F5	T5	
HYUNDAI®	DAKAR EVO	F5	T5	
	DAKAR UP	F5	T5	
	DAKAR EASY	F5	T5	
	Dakar	F5	T5	
HYN13P	DAKAR EVO	F11	T11	
	DAKAR UP	F11	T11	
	DAKAR EASY	F11	T11	
	Dakar	F11	T11	
HYN14C1	DAKAR EVO	F11	T11	
	DAKAR UP	F11	T11	
	DAKAR EASY	F11	T11	
	Dakar	F11	T11	
HYN14P	DAKAR EVO	F11	T11	
	DAKAR UP	F11	T11	
	DAKAR EASY	F11	T11	
	Dakar	F11	T11	
T00HYN13P	DAKAR EVO	F11	T11	
	DAKAR UP	F11	T11	
	DAKAR EASY	F11	T11	
	Dakar	F11	T11	
T00HYN13T	DAKAR EVO	F11	T11	
	DAKAR UP	F11	T11	
	DAKAR EASY	F11	T11	
	Dakar	F11	T11	
T00HYN14P	DAKAR EVO	F11	T11	
	DAKAR UP	F11	T11	
	DAKAR EASY	F11	T11	
	Dakar	F11	T11	



HYUNDAI®	T00HYN14P	DAKAR UP	F11	T11		
		DAKAR EASY	F11	T11		
		Dakar	F11	T11		
		Dakar Express	F11	T11		
IBFM®	IBF2R	DAKAR EVO	F26	T26		
		DAKAR UP	F26	T26		
		DAKAR EASY	F26	T26		
		Dakar	F26	T26		
		Dakar Express	F26	T26		
IFAM®	IF2	DAKAR EVO	F1	T1		
		DAKAR UP	F1	T1		
		DAKAR EASY	F1	T1		
		Dakar	F1	T1		
		Dakar Express	F1	T1		
	IF12	DAKAR EVO	F19	T19		
		DAKAR UP	F19	T19		
		DAKAR EASY	F19	T19		
		Dakar	F19	T19		
		Dakar Express	F19	T19		
	IF13	DAKAR EVO	F19	T19		
		DAKAR UP	F19	T19		
		DAKAR EASY	F19	T19		
		Dakar	F19	T19		
		Dakar Express	F19	T19		
	IF14	DAKAR EVO	F19	T19		
		DAKAR UP	F19	T19		
		DAKAR EASY	F19	T19		
		Dakar	F19	T19		
		Dakar Express	F19	T19		
	ORIGINAL IF1921	DAKAR EVO	F1	T1		
		DAKAR UP	F1	T1		
		DAKAR EASY	F1	T1		
		Dakar	F1	T1		
		Dakar Express	F1	T1		
	ORIGINAL IF1927	DAKAR EVO	BF3-3T	T3		
		DAKAR UP	BF3-3T	T3		
		DAKAR EASY	BF3-3T	T3		
		Dakar	BF3-3T	T3		
		Dakar Express	BF3-3T	T3		
	INCECA®	INC1T	DAKAR EVO	F8	T8	
			DAKAR UP	F8	T8	FIC-TUB
Dakar			F8	T8		
Dakar Express			F8	T8	FIC-TUB	
INC2T		DAKAR EVO	F8	T8		
		DAKAR UP	F8	T8	FIC-TUB	



INCECA®	INC2T	Dakar	F8	T8		
		Dakar Express	F8	T8	FIC-TUB	
IR®	IR1P164	DAKAR EVO	F1	T1		
		DAKAR UP	F1	T1		
		DAKAR EASY	F1	T1		
		Dakar	F1	T1		
		Dakar Express	F1	T1		
ISEO®	I15	DAKAR EVO	F26	T26		
		DAKAR UP	F26	T26		
		DAKAR EASY	F26	T26		
		Dakar	F26	T26		
		Dakar Express	F26	T26		
	I16	DAKAR EVO	F26	T26		
		DAKAR UP	F26	T26		
		DAKAR EASY	F26	T26		
		Dakar	F26	T26		
		Dakar Express	F26	T26		
	I20	DAKAR EVO	F26	T26		
		DAKAR UP	F26	T26		
		DAKAR EASY	F26	T26		
		Dakar	F26	T26		
		Dakar Express	F26	T26		
	I22	DAKAR EVO	F26	T26		
		DAKAR UP	F26	T26		
		DAKAR EASY	F26	T26		
		Dakar	F26	T26		
		Dakar Express	F26	T26		
	ITO®	ITO2	DAKAR EVO	F26	T26	
			DAKAR UP	F26	T26	
DAKAR EASY			F26	T26		
Dakar			F26	T26		
Dakar Express			F26	T26		
ITO3		DAKAR EVO	F1	T1		
		DAKAR UP	F1	T1		
		DAKAR EASY	F1	T1		
		Dakar	F1	T1		
		Dakar Express	F1	T1		
JAGUAR®	JAG1	DAKAR EVO	F1	T1		
		DAKAR UP	F1	T1		
		DAKAR EASY	F1	T1		
		Dakar	F1	T1		



JIS®	JIS4P	DAKAR EVO	F11	T11	AD-JIS
		DAKAR UP	F11	T11	AD-JIS
		DAKAR EASY	F11	T11	AD-JIS
		Dakar	F11	T11	AD-JIS
		Dakar Express	F11	T11	AD-JIS
KABA®	KB1	DAKAR EVO	F1	T1	
		DAKAR UP	F1	T1	
		DAKAR EASY	F1	T1	
		Dakar	F1	T1	
		Dakar Express	F1	T1	
	KB2	DAKAR EVO	F43	T43	45°
			F1	T1	45°
		DAKAR UP	F43	T43	AD-MKA
			F1	T1	AD-MKA
		DAKAR EASY	F43	T43	AD-MKA
			F1	T1	AD-MKA
		Dakar	F43	T43	45°
			F1	T1	45°
		Dakar Express	F43	T43	AD-MKA
			F1	T1	AD-MKA
	KB2N	DAKAR EVO	F43	T43	45°
			F1	T1	45°
		DAKAR UP	F43	T43	AD-MKA
			F1	T1	AD-MKA
		DAKAR EASY	F43	T43	AD-MKA
			F1	T1	AD-MKA
		Dakar	F43	T43	45°
			F1	T1	45°
		Dakar Express	F43	T43	AD-MKA
			F1	T1	AD-MKA
	KB3	DAKAR EVO	F1	T1	
		DAKAR UP	F1	T1	
		DAKAR EASY	F1	T1	
		Dakar	F1	T1	
		Dakar Express	F1	T1	
	KB3N	DAKAR EVO	F1	T1	
		DAKAR UP	F1	T1	
		DAKAR EASY	F1	T1	
		Dakar	F1	T1	
		Dakar Express	F1	T1	
	KB4	DAKAR EVO	F43	T43	15°
		DAKAR UP	F43	T43	AD-MB
		DAKAR EASY	F43	T43	AD-MB
		Dakar	F43	T43	15°
		Dakar Express	F43	T43	AD-MB



KABA®	KB5	DAKAR EVO	F1	T26	15°
			F1	T26	45°
		DAKAR UP	F1	T26	AD-MB
			F1	T26	AD-MKA
		DAKAR EASY	F1	T26	AD-MB
			F1	T26	AD-MKA
		Dakar	F1	T26	15°
			F1	T26	45°
		Dakar Express	F1	T26	AD-MB
			F1	T26	
	KB6	DAKAR EVO	F1	T1	
		DAKAR UP	F1	T1	
		DAKAR EASY	F1	T1	
		Dakar	F1	T1	
		Dakar Express	F1	T1	
	KB7	DAKAR EVO	F20	T20	PIA-MKB
		DAKAR UP	F20	T20	PIA-MKB
		DAKAR EASY	F20	T20	PIA-MKB
		Dakar	F20	T20	PIA-MKB
		Dakar Express	F20	T20	PIA-MKB
KALE®	KAL2	DAKAR EVO	F1	T1	
		DAKAR UP	F1	T1	
		DAKAR EASY	F1	T1	
		Dakar	F1	T1	
		Dakar Express	F1	T1	
	KAL3	DAKAR EVO	F1	T1	
		DAKAR UP	F1	T1	
		DAKAR EASY	F1	T1	
		Dakar	F1	T1	
		Dakar Express	F1	T1	
	KAL4	DAKAR EVO	F1	T1	
		DAKAR UP	F1	T1	
		DAKAR EASY	F1	T1	
		Dakar	F1	T1	
		Dakar Express	F1	T1	
	KAL7	DAKAR EVO	F1	T1	
		DAKAR UP	F1	T1	
		DAKAR EASY	F1	T1	
		Dakar	F1	T1	
		Dakar Express	F1	T1	
	KAL11	DAKAR EVO	F1	T1	
		DAKAR UP	F1	T1	
		DAKAR EASY	F1	T1	
		Dakar	F1	T1	
		Dakar Express	F1	T1	



KALE®						
KAL12	DAKAR EVO	F1	T1			
	DAKAR UP	F1	T1			
	DAKAR EASY	F1	T1			
	Dakar	F1	T1			
	Dakar Express	F1	T1			
	KAL13	DAKAR EVO	F1	T1		
		DAKAR UP	F1	T1		
		DAKAR EASY	F1	T1		
		Dakar	F1	T1		
		Dakar Express	F1	T1		
KESO®						
KC1	DAKAR EVO	F1	T1	AD-PL5		
		F20	T20			
	DAKAR UP	F1	T1	AD-MK5		
		F20	T20			
	DAKAR EASY	F1	T1	AD-MK5		
		F20	T20			
	Dakar	F1	T1	AD-PL5		
		F20	T20			
	Dakar Express	F1	T1	AD-MK5		
		F20	T20			
KC2	DAKAR EVO	F1	T1	<01.01.92		
		BF12	BT12	>01.01.92		
	DAKAR UP	F1	T1	<01.01.92		
		BF12	BT12	>01.01.92		
	DAKAR EASY	F1	T1	<01.01.92		
		BF12	BT12	>01.01.92		
	Dakar	F1	T1	<01.01.92		
		BF12	BT12	>01.01.92		
	Dakar Express	F1	T1	<01.01.92		
		BF12	BT12	>01.01.92		
KC2T	DAKAR EVO	BF12	BT12			
	DAKAR UP	BF12	BT12			
	DAKAR EASY	BF12	BT12			
	Dakar	BF12	BT12			
	Dakar Express	BF12	BT12			
KC3	DAKAR EVO	BF12	BT12			
	DAKAR UP	BF12	BT12			
	DAKAR EASY	BF12	BT12			
	Dakar	BF12	BT12			
	Dakar Express	BF12	BT12			
KC4	DAKAR EVO	BF12	BT12			
	DAKAR UP	BF12	BT12			
	DAKAR EASY	BF12	BT12			
	Dakar	BF12	BT12			
	Dakar Express	BF12	BT12			



KESO®				
KC5	DAKAR EVO	F1	T1	
		FS31	TS31	
	DAKAR UP	F1	T1	
		FS31	TS31	
	DAKAR EASY	F1	T1	
		FS31	TS31	
	Dakar	F1	T1	
		FS31	TS31	
	Dakar Express	F1	T1	
		FS31	TS31	
KC6	DAKAR UP	F1	T1	
		FS31	TS31	
	DAKAR EASY	F1	T1	
		FS31	TS31	
	Dakar	F1	T1	
		FS31	TS31	
	Dakar Express	F1	T1	
		FS31	TS31	
		FS31	TS31	
		FS31	TS31	
KFV-FCV®				
KF4	DAKAR EVO	F5	T5	
	DAKAR UP	F5	T5	
	DAKAR EASY	F5	T5	
	Dakar	F5	T5	
	Dakar Express	F5	T5	
KIA®				
KIA8P181	DAKAR EVO	F11	T11	
	DAKAR UP	F11	T11	
	DAKAR EASY	F11	T11	
	Dakar	F11	T11	
	Dakar Express	F11	T11	
KIA8RP181	DAKAR EVO	F11	T11	
	DAKAR UP	F11	T11	
	DAKAR EASY	F11	T11	
	Dakar	F11	T11	
T00KIA7P	DAKAR EVO	F11	T11	
	DAKAR UP	F11	T11	
	DAKAR EASY	F11	T11	
	Dakar	F11	T11	
T00KIA8P	DAKAR EVO	F11	T11	
	DAKAR UP	F11	T11	
	DAKAR EASY	F11	T11	
	Dakar	F11	T11	
T00KIA8RP	DAKAR EVO	F11	T11	
	DAKAR UP	F11	T11	
	DAKAR EASY	F11	T11	
	Dakar	F11	T11	



FOR:	ERREBI	Icon 1	Icon 2	Icon 3	Icon 4	
KIA®	T00KIA8RP	DAKAR UP	F11	T11		
		DAKAR EASY	F11	T11		
		Dakar	F11	T11		
		Dakar Express	F11	T11		
	T00KIA10P	DAKAR EVO	F11	T11		
		DAKAR UP	F11	T11		
		DAKAR EASY	F11	T11		
		Dakar	F11	T11		
		Dakar Express	F11	T11		
		KM1P	DAKAR EVO	F11	T11	
			DAKAR UP	F11	T11	
			DAKAR EASY	F11	T11	
Dakar	F11		T11			
	Dakar Express	F11	T11			
	LA31	DAKAR EVO	F13	T13		
		DAKAR UP	F13	T13		
		DAKAR EASY	F13	T13		
Dakar		F13	T13			
Dakar Express		F13	T13			
LA33P65	DAKAR EVO	F13	T13			
	DAKAR UP	F13	T13			
	DAKAR EASY	F13	T13			
	Dakar	F13	T13			
	Dakar Express	F13	T13			
LA40	DAKAR EVO	F13	T13			
	DAKAR UP	F13	T13			
	DAKAR EASY	F13	T13			
	Dakar	F13	T13			
	Dakar Express	F13	T13			
LP610	DAKAR EVO	F8	T8	FIC-TUB		
	DAKAR UP	F8	T8			
	Dakar	F8	T8			
	Dakar Express	F8	T8	FIC-TUB		
LP620	DAKAR EVO	F8	T8			
	DAKAR UP	F8	T8	FIC-TUB		
	Dakar	F8	T8			
	Dakar Express	F8	T8	FIC-TUB		
LINCE®	LI9R	DAKAR EVO	F5	T5		
		DAKAR UP	F5	T5		
		DAKAR EASY	F5	T5		
		Dakar	F5	T5		
		Dakar Express	F5	T5		
		LI16R	DAKAR EVO	F5	T5	
			DAKAR UP	F5	T5	
			DAKAR EASY	F5	T5	



FOR:	ERREBI	Icon 1	Icon 2	Icon 3	Icon 4	
LINCE®	LI16R	Dakar	F5	T5		
		Dakar Express	F5	T5		
	LI17R	DAKAR EVO	F5	T5		
		DAKAR UP	F5	T5		
		DAKAR EASY	F5	T5		
		Dakar	F5	T5		
		Dakar Express	F5	T5		
		LI18R	DAKAR EVO	F5	T5	
			DAKAR UP	F5	T5	
			DAKAR EASY	F5	T5	
	Dakar		F5	T5		
		Dakar Express	F5	T5		
		ORIGINAL C2/C3/C4	DAKAR EVO	F5	T5	
			DAKAR UP	F5	T5	
			DAKAR EASY	F5	T5	
	Dakar		F5	T5		
		Dakar Express	F5	T5		
		ORIGINAL C5	DAKAR EVO	F5	T5	
DAKAR UP			F5	T5		
DAKAR EASY			F5	T5		
Dakar	F5		T5			
	Dakar Express	F5	T5			
	LKS1	DAKAR EVO	F1	T1		
		DAKAR UP	F1	T1		
		DAKAR EASY	F1	T1		
Dakar		F1	T1			
Dakar Express		F1	T1			
LT®		LT1	DAKAR EVO	F1	T1	
	DAKAR UP		F1	T1		
	DAKAR EASY		F1	T1		
	Dakar		F1	T1		
	Dakar Express	F1	T1			
	LYF®	LYF2T	DAKAR EVO	F8	T8	
			DAKAR UP	F8	T8	FIC-TUB
			Dakar	F8	T8	
Dakar Express			F8	T8	FIC-TUB	
MAGNUM®	MGN1RP76	DAKAR EVO	F19	T19	14°	
		DAKAR EVO	F3	T3		
		Dakar	F19	T19	14°	
		Dakar	F3	T3		
	MGN2R	DAKAR EVO	F19	T19	14°	
		DAKAR EVO	F3	T3		
	Dakar	F19	T19	14°		
	Dakar	F3	T3			
	MAHINDRA®	T00MHN1P	DAKAR EVO	F11	T11	



MAHINDRA®	T00MHN1P	DAKAR UP	F11	T11	
		DAKAR EASY	F11	T11	
		Dakar	F11	T11	
		Dakar Express	F11	T11	
MASTER®	M19P154	DAKAR EVO	F6	T6	
		DAKAR UP	F6	T6	
		DAKAR EASY	F6	T6	
		Dakar	F6	T6	
		Dakar Express	F6	T6	
MASTER LOCK®	MAS1	DAKAR EVO	F1	T1	
		DAKAR UP	F1	T1	
		DAKAR EASY	F1	T1	
		Dakar	F1	T1	
		Dakar Express	F1	T1	
	MAS2	DAKAR EVO	F1	T1	10°
		DAKAR UP	F1	T1	
		DAKAR EASY	F1	T1	
		Dakar	F1	T1	
		Dakar Express	F1	T1	
MAUER®	MAU4	DAKAR EVO	F1	T1	
		DAKAR UP	F1	T1	
		DAKAR EASY	F1	T1	
		Dakar	F1	T1	
		Dakar Express	F1	T1	
	ORIGINAL NW4	DAKAR EVO	F13	T13	
MAZDA®	MZ22P113	DAKAR EVO	F17	T17	
		DAKAR UP	F17	T17	
		DAKAR EASY	F17	T17	
		Dakar	F17	T17	
		Dakar Express	F17	T17	
MCM®	MD12	DAKAR EVO	F1	T1	
		DAKAR EVO	FB	TB	
		DAKAR EVO	FC	TC	
		DAKAR UP	F1	T1	
		DAKAR UP	FB	TB	
		DAKAR UP	FC	TC	
		DAKAR EASY	F1	T1	
		DAKAR EASY	FB	TB	
		DAKAR EASY	FC	TC	
		Dakar	F1	T1	
		Dakar	FB	TB	
		Dakar	FC	TC	
		Dakar Express	F1	T1	
		Dakar Express	FB	TB	
		Dakar Express	FC	TC	



MCM®	MD12	Dakar Express	FC	TC	
	MD13R	DAKAR EVO	F13	T13	
		DAKAR UP	F13	T13	AD-MCM
		DAKAR EASY	F13	T13	AD-MCM
		Dakar	F13	T13	
		Dakar Express	F13	T13	AD-MCM
	MD17	DAKAR EVO	F13	T13	
		DAKAR UP	F13	T13	
		DAKAR EASY	F13	T13	
		Dakar	F13	T13	
		Dakar Express	F13	T13	
	MD25	DAKAR EVO	F1	T1	
		DAKAR EVO	FB	TB	
		DAKAR EVO	FC	TC	
		DAKAR UP	F1	T1	
DAKAR UP		FB	TB		
DAKAR UP		FC	TC		
DAKAR EASY		F1	T1		
DAKAR EASY		FB	TB		
DAKAR EASY		FC	TC		
Dakar		F1	T1		
MD26	DAKAR EVO	F13	T13		
	DAKAR UP	F13	T13		
	DAKAR EASY	F13	T13		
	Dakar	F13	T13		
	Dakar Express	F13	T13		
MD27	DAKAR EVO	F13	T13		
	DAKAR UP	F13	T13		
	DAKAR EASY	F13	T13		
	Dakar	F13	T13		
	Dakar Express	F13	T13		
MD30	DAKAR EVO	F13	T13		
	DAKAR UP	F13	T13		
	DAKAR EASY	F13	T13		
	Dakar	F13	T13		
	Dakar Express	F13	T13		
	Dakar Express	F13	T13		
MERONI®	MR23T	DAKAR EVO	F8W	T8	
		DAKAR UP	F8W	T8	FIC-TUB
		Dakar	F8W	T8	



MERONI®	MR23T	Dakar Express	F8W	T8	FIC-TUB
	MR24T	DAKAR EVO	F8W	T8	
		DAKAR UP	F8W	T8	FIC-TUB
		Dakar	F8W	T8	
		Dakar Express	F8W	T8	FIC-TUB
	MR26T	DAKAR EVO	F8W	T8	
		DAKAR UP	F8W	T8	FIC-TUB
		Dakar	F8W	T8	
		Dakar Express	F8W	T8	FIC-TUB
	MR33	DAKAR EVO	F11	T11	
		DAKAR UP	F11	T11	
		DAKAR EASY	F11	T11	
		Dakar	F11	T11	
		Dakar Express	F11	T11	
MHA®	MH1	DAKAR EVO	F5	T5	
		DAKAR UP	F5	T5	
		DAKAR EASY	F5	T5	
		Dakar	F5	T5	
		Dakar Express	F5	T5	
MLM	MLM5	DAKAR EVO	F1	T1	
		DAKAR UP	F1	T1	
		DAKAR EASY	F1	T1	
		Dakar	F1	T1	
		Dakar Express	F1	T1	
	MLM6	DAKAR EVO	F3	T3	
		DAKAR UP	F3	T3	
		DAKAR EASY	F3	T3	
		Dakar	F3	T3	
		Dakar Express	F3	T3	
MOIA	MA6	DAKAR EVO	F1	T1	
		DAKAR UP	F1	T1	
		DAKAR EASY	F1	T1	
		Dakar	F1	T1	
		Dakar Express	F1	T1	
	MA7	DAKAR EVO	F1	T1	
		DAKAR UP	F1	T1	
		DAKAR EASY	F1	T1	
		Dakar	F1	T1	
		Dakar Express	F1	T1	
	MA8	DAKAR EVO	F1	T1	
		DAKAR UP	F1	T1	
		DAKAR EASY	F1	T1	
		Dakar	F1	T1	
		Dakar Express	F1	T1	



MONTI -MG®	MG10	DAKAR EVO	F26	T26	
		DAKAR UP	F26	T26	
		DAKAR EASY	F26	T26	
		Dakar	F26	T26	
		Dakar Express	F26	T26	
	MG11	DAKAR EVO	F26	T26	
		DAKAR UP	F26	T26	
		DAKAR EASY	F26	T26	
		Dakar	F26	T26	
		Dakar Express	F26	T26	
	MG12	DAKAR EVO	F26	T26	
		DAKAR UP	F26	T26	
		DAKAR EASY	F26	T26	
		Dakar	F26	T26	
		Dakar Express	F26	T26	
	MG12R	DAKAR EVO	F26	T26	
		DAKAR UP	F26	T26	
		DAKAR EASY	F26	T26	
		Dakar	F26	T26	
		Dakar Express	F26	T26	
MOTTURA®	MO3	DAKAR EVO	F5	T5	
		DAKAR UP	F5	T5	
		DAKAR EASY	F5	T5	
		Dakar	F5	T5	
		Dakar Express	F5	T5	
	MO3P179	DAKAR EVO	F5	T5	
		DAKAR UP	F5	T5	
		DAKAR EASY	F5	T5	
		Dakar	F5	T5	
		Dakar Express	F5	T5	
	MO4P179	DAKAR EVO	F1	T1	
		DAKAR UP	F1	T1	
		DAKAR EASY	F1	T1	
		Dakar	F1	T1	
		Dakar Express	F1	T1	
MSM®	MSM1	DAKAR EVO	F19	T19	
		DAKAR UP	F19	T19	
		DAKAR EASY	F19	T19	
		Dakar	F19	T19	
		Dakar Express	F19	T19	
MULT.LOCK®	MLT1P76	DAKAR EVO	F12A	T12A	
			F12B	T12B	
		DAKAR UP	F12A	T12A	
			F12B	T12B	

FOR:



MULT.LOCK®

MLT1P76	DAKAR EASY	F12A	T12A
		F12B	T12B
Dakar	DAKAR EASY	F12A	T12A
		F12B	T12B
Dakar Express	DAKAR EASY	F12A	T12A
		F12B	T12B
MLT1RDSP76	DAKAR EVO	F12A	T12A
		F12B	T12B
DAKAR UP	DAKAR EVO	F12A	T12A
		F12B	T12B
DAKAR EASY	DAKAR EVO	F12A	T12A
		F12B	T12B
Dakar	DAKAR EVO	F12A	T12A
		F12B	T12B
Dakar Express	DAKAR EVO	F12A	T12A
		F12B	T12B
MLT1RP76	DAKAR EVO	F12A	T12A
		F12B	T12B
DAKAR UP	DAKAR EVO	F12A	T12A
		F12B	T12B
DAKAR EASY	DAKAR EVO	F12A	T12A
		F12B	T12B
Dakar	DAKAR EVO	F12A	T12A
		F12B	T12B
Dakar Express	DAKAR EVO	F12A	T12A
		F12B	T12B
MLT2RP76	DAKAR EVO	F12A	T12A
		F12B	T12B
DAKAR UP	DAKAR EVO	F12A	T12A
		F12B	T12B
DAKAR EASY	DAKAR EVO	F12A	T12A
		F12B	T12B
Dakar	DAKAR EVO	F12A	T12A
		F12B	T12B
Dakar Express	DAKAR EVO	F12A	T12A
		F12B	T12B
MLT3P76	DAKAR EVO	F12A	T12A
		F12B	T12B
DAKAR UP	DAKAR EVO	F12A	T12A
		F12B	T12B
DAKAR EASY	DAKAR EVO	F12A	T12A
		F12B	T12B
Dakar	DAKAR EVO	F12A	T12A
		F12B	T12B
Dakar Express	DAKAR EVO	F12A	T12A
		F12B	T12B

FOR:



MULT.LOCK®

MLT3P76	Dakar Express	F12B	T12B
		F12B	T12B
MLT7RP76	DAKAR EVO	F12A	T12A
		F12B	T12B
DAKAR UP	DAKAR EVO	F12A	T12A
		F12B	T12B
DAKAR EASY	DAKAR EVO	F12A	T12A
		F12B	T12B
Dakar	DAKAR EVO	F12A	T12A
		F12B	T12B
Dakar Express	DAKAR EVO	F12A	T12A
		F12B	T12B
MLT8RP176	DAKAR EVO	F12A	T12A
		F12B	T12B
DAKAR UP	DAKAR EVO	F12A	T12A
		F12B	T12B
DAKAR EASY	DAKAR EVO	F12A	T12A
		F12B	T12B
Dakar	DAKAR EVO	F12A	T12A
		F12B	T12B
Dakar Express	DAKAR EVO	F12A	T12A
		F12B	T12B
MLT9P176	DAKAR EVO	F12A	T12A
		F12B	T12B
DAKAR UP	DAKAR EVO	F12A	T12A
		F12B	T12B
DAKAR EASY	DAKAR EVO	F12A	T12A
		F12B	T12B
Dakar	DAKAR EVO	F12A	T12A
		F12B	T12B
Dakar Express	DAKAR EVO	F12A	T12A
		F12B	T12B
MLT10RP76	DAKAR EVO	F12A	T12A
		F12B	T12B
DAKAR UP	DAKAR EVO	F12A	T12A
		F12B	T12B
DAKAR EASY	DAKAR EVO	F12A	T12A
		F12B	T12B
Dakar	DAKAR EVO	F12A	T12A
		F12B	T12B
Dakar Express	DAKAR EVO	F12A	T12A
		F12B	T12B
MLT11RP169	DAKAR EVO	F12A	T12A
		F12B	T12B
DAKAR UP	DAKAR EVO	F12A	T12A
		F12B	T12B



MULT.LOCK®					
MLT11RP169	DAKAR EASY	F12A	T12A		
		F12B	T12B		
	Dakar	F12A	T12A		
		F12B	T12B		
	Dakar Express	F12A	T12A		
		F12B	T12B		
	MLT12RP169	DAKAR EVO	F12A	T12A	
			F12B	T12B	
		DAKAR UP	F12A	T12A	
			F12B	T12B	
		DAKAR EASY	F12A	T12A	
			F12B	T12B	
Dakar		F12A	T12A		
		F12B	T12B		
Dakar Express		F12A	T12A		
		F12B	T12B		
MLT13RP169		DAKAR EVO	F12A	T12A	
			F12B	T12B	
	DAKAR UP	F12A	T12A		
		F12B	T12B		
	DAKAR EASY	F12A	T12A		
		F12B	T12B		
	Dakar	F12A	T12A		
		F12B	T12B		
	Dakar Express	F12A	T12A		
		F12B	T12B		
	MLT14R	DAKAR EVO	F12A	T12A	
			F12B	T12B	
DAKAR UP		F12A	T12A		
		F12B	T12B		
DAKAR EASY		F12A	T12A		
		F12B	T12B		
Dakar		F12A	T12A		
		F12B	T12B		
Dakar Express		F12A	T12A		
		F12B	T12B		
MLT15RP169		DAKAR EVO	F12A	T12A	
			F12B	T12B	
	DAKAR UP	F12A	T12A		
		F12B	T12B		
	DAKAR EASY	F12A	T12A		
		F12B	T12B		



MULT.LOCK®					
MLT15RP169	Dakar	F12A	T12A		
		F12B	T12B		
	Dakar Express	F12A	T12A		
		F12B	T12B		
	MLT16RP169	DAKAR EVO	F12A	T12A	
			F12B	T12B	
		DAKAR UP	F12A	T12A	
			F12B	T12B	
		DAKAR EASY	F12A	T12A	
			F12B	T12B	
		Dakar	F12A	T12A	
			F12B	T12B	
Dakar Express		F12A	T12A		
		F12B	T12B		
ORIGINAL INTERACTIVE L / R		DAKAR EVO	F12A	T12A	
			F12B	T12B	
	DAKAR UP	F12A	T12A		
		F12B	T12B		
	DAKAR EASY	F12A	T12A		
		F12B	T12B		
	Dakar	F12A	T12A		
		F12B	T12B		
	Dakar Express	F12A	T12A		
		F12B	T12B		
	ORIGINAL MT5	DAKAR EVO	F12A	T12A	
			F12B	T12B	
DAKAR UP		F12A	T12A		
		F12B	T12B		
DAKAR EASY		F12A	T12A		
		F12B	T12B		
Dakar		F12A	T12A		
		F12B	T12B		
Dakar Express		F12A	T12A		
		F12B	T12B		
NEIMAN®		NE70P70	DAKAR EVO	F17	T17
			DAKAR UP	F17	T17
	DAKAR EASY		F17	T17	
	NE71P71	Dakar	F17	T17	
		Dakar Express	F17	T17	
		DAKAR EVO	F17	T17	
		DAKAR UP	F17	T17	



NEIMAN®	NE71P71	DAKAR EASY	F17	T17
		Dakar	F17	T17
		Dakar Express	F17	T17
	NE81C1	DAKAR EVO	F17	T17
		DAKAR UP	F17	T17
		DAKAR EASY	F17	T17
		Dakar	F17	T17
		Dakar Express	F17	T17
	NE81P115	DAKAR EVO	F17	T17
		DAKAR UP	F17	T17
		DAKAR EASY	F17	T17
		Dakar	F17	T17
		Dakar Express	F17	T17
	T00NE70P	DAKAR EVO	F17	T17
		DAKAR UP	F17	T17
		DAKAR EASY	F17	T17
		Dakar	F17	T17
		Dakar Express	F17	T17
	T00NE81PA	DAKAR EVO	F17	T17
		DAKAR UP	F17	T17
	DAKAR EASY	F17	T17	
	Dakar	F17	T17	
	Dakar Express	F17	T17	
NOORI®	NOR1	DAKAR EVO	F26	T26
		DAKAR UP	F26	T26
		DAKAR EASY	F26	T26
		Dakar	F26	T26
		Dakar Express	F26	T26
	NOR1R	DAKAR EVO	F26	T26
		DAKAR UP	F26	T26
		DAKAR EASY	F26	T26
		Dakar	F26	T26
		Dakar Express	F26	T26
OJMAR®	OJ22	DAKAR EVO	F5	T5
		DAKAR UP	F5	T5
		DAKAR EASY	F5	T5
		Dakar	F5	T5
		Dakar Express	F5	T5
	OJ27	DAKAR EVO	F1	T1
		DAKAR UP	F1	T1
		DAKAR EASY	F1	T1
		Dakar	F1	T1



OJMAR®	OJ27	Dakar Express	F1	T1	
OMECC®	O7	DAKAR EVO	F1	T1	
		DAKAR UP	F1	T1	
		DAKAR EASY	F1	T1	
		Dakar	F1	T1	
		Dakar Express	F1	T1	
	O8	DAKAR EVO	F1	T1	
		DAKAR UP	F1	T1	
		DAKAR EASY	F1	T1	
		Dakar	F1	T1	
		Dakar Express	F1	T1	
	O11	DAKAR EVO	F1	T1	
		DAKAR UP	F1	T1	
		DAKAR EASY	F1	T1	
		Dakar	F1	T1	
		Dakar Express	F1	T1	
P.C.® (Cortellezzi)	PA6T	DAKAR EVO	F8	T8	
		DAKAR UP	F8	T8	FIC-TUB
		Dakar	F8	T8	
		Dakar Express	F8	T8	FIC-TUB
	PA6TP	DAKAR EVO	F8	T8	
		DAKAR UP	F8	T8	FIC-TUB
		Dakar	F8	T8	
		Dakar Express	F8	T8	FIC-TUB
	PA7T	DAKAR EVO	F8	T8	
		DAKAR UP	F8	T8	FIC-TUB
	Dakar	F8	T8		
	Dakar Express	F8	T8	FIC-TUB	
PENZMASH®	PNZ2	DAKAR EVO	F1	T1	
		DAKAR UP	F1	T1	
		DAKAR EASY	F1	T1	
		Dakar	F1	T1	
		Dakar Express	F1	T1	
PERINO®	PR2	DAKAR EVO	F11	T11	
		DAKAR UP	F11	T11	
		DAKAR EASY	F11	T11	
		Dakar	F11	T11	
		Dakar Express	F11	T11	
PFAFFENHAIN®	PH14R	DAKAR EVO	F34	T34	AD-PH
		DAKAR UP	F34	T34	AD-PH
		DAKAR EASY	F34	T34	AD-PH



PFAFFENHAIN®					
PH14R	Dakar	F34	T34	AD-PH	
	Dakar Express	F34	T34	AD-PH	
DAKAR EVO	F34	T34	AD-PH		
DAKAR UP	F34	T34	AD-PH		
DAKAR EASY	F34	T34	AD-PH		
Dakar	F34	T34	AD-PH		
Dakar Express	F34	T34	AD-PH		
PH16R	DAKAR EVO	F34	T34	AD-PH	
	DAKAR UP	F34	T34	AD-PH	
	DAKAR EASY	F34	T34	AD-PH	
	Dakar	F34	T34	AD-PH	
Dakar Express	F34	T34	AD-PH		
PH17R	DAKAR EVO	F34	T34	AD-PH	
	DAKAR UP	F34	T34	AD-PH	
	DAKAR EASY	F34	T34	AD-PH	
	Dakar	F34	T34	AD-PH	
Dakar Express	F34	T34	AD-PH		
PH18	DAKAR EVO	F34	T34	AD-PH	
	DAKAR UP	F34	T34	AD-PH	
	DAKAR EASY	F34	T34	AD-PH	
	Dakar	F34	T34	AD-PH	
	Dakar Express	F34	T34	AD-PH	
PH19	DAKAR EVO	F34	T34	AD-PH	
	DAKAR UP	F34	T34	AD-PH	
	DAKAR EASY	F34	T34	AD-PH	
	Dakar	F34	T34	AD-PH	
	Dakar Express	F34	T34	AD-PH	
PH19R	DAKAR EVO	F34	T34	AD-PH	
	DAKAR UP	F34	T34	AD-PH	
	DAKAR EASY	F34	T34	AD-PH	
	Dakar	F34	T34	AD-PH	
	Dakar Express	F34	T34	AD-PH	
PH21R	DAKAR EVO	F34	T34	AD-PH	
	DAKAR UP	F34	T34	AD-PH	
	DAKAR EASY	F34	T34	AD-PH	
	Dakar	F34	T34	AD-PH	
	Dakar Express	F34	T34	AD-PH	
PH22R	DAKAR EVO	F34	T34	AD-PH	
	DAKAR UP	F34	T34	AD-PH	
	DAKAR EASY	F34	T34	AD-PH	
	Dakar	F34	T34	AD-PH	
	Dakar Express	F34	T34	AD-PH	
PH26	DAKAR EVO	F34	T34	AD-PH	
	DAKAR UP	F34	T34	AD-PH	
	DAKAR EASY	F34	T34	AD-PH	



PFAFFENHAIN®					
PH26	Dakar	F34	T34	AD-PH	
	Dakar Express	F34	T34	AD-PH	
PH27	DAKAR EVO	F34	T34	AD-PH	
	DAKAR UP	F34	T34	AD-PH	
	DAKAR EASY	F34	T34	AD-PH	
	Dakar	F34	T34	AD-PH	
Dakar Express	F34	T34	AD-PH		
PH28	DAKAR EVO	F34	T34	AD-PH	
	DAKAR UP	F34	T34	AD-PH	
	DAKAR EASY	F34	T34	AD-PH	
	Dakar	F34	T34	AD-PH	
Dakar Express	F34	T34	AD-PH		
PH29	DAKAR EVO	F34	T34	AD-PH	
	DAKAR UP	F34	T34	AD-PH	
	DAKAR EASY	F34	T34	AD-PH	
	Dakar	F34	T34	AD-PH	
Dakar Express	F34	T34	AD-PH		
PH29R	DAKAR EVO	F34	T34	AD-PH	
	DAKAR UP	F34	T34	AD-PH	
	DAKAR EASY	F34	T34	AD-PH	
	Dakar	F34	T34	AD-PH	
Dakar Express	F34	T34	AD-PH		
PH30R	DAKAR EVO	F34	T34	AD-PH	
	DAKAR UP	F34	T34	AD-PH	
	DAKAR EASY	F34	T34	AD-PH	
	Dakar	F34	T34	AD-PH	
Dakar Express	F34	T34	AD-PH		
PH31	DAKAR EVO	F34	T34	AD-PH	
	DAKAR UP	F34	T34	AD-PH	
	DAKAR EASY	F34	T34	AD-PH	
	Dakar	F34	T34	AD-PH	
Dakar Express	F34	T34	AD-PH		
PH32	DAKAR EVO	F34	T34	AD-PH	
	DAKAR UP	F34	T34	AD-PH	
	DAKAR EASY	F34	T34	AD-PH	
	Dakar	F34	T34	AD-PH	
Dakar Express	F34	T34	AD-PH		
PICARD®	PIC1	DAKAR EVO	F1	T1	
		DAKAR UP	F1	T1	
		DAKAR EASY	F1	T1	
		Dakar	F1	T1	
		Dakar Express	F1	T1	
PICARD- VIGIE®	VP8	DAKAR EVO	F8	T8	
		DAKAR UP	F8	T8	
				FIC-TUB	



PICARD-VIGIE®	VP8	Dakar	F8	T8	
		Dakar Express	F8	T8	FIC-TUB
POTENT®	PN1R	DAKAR EVO	F1	T1	
		DAKAR UP	F1	T1	
		DAKAR EASY	F1	T1	
		Dakar	F1	T1	
		Dakar Express	F1	T1	
	PN3R	DAKAR EVO	F1	T1	
		DAKAR UP	F1	T1	
		DAKAR EASY	F1	T1	
		Dakar	F1	T1	
	PN5R	DAKAR EVO	F1	T1	
		DAKAR UP	F1	T1	
		DAKAR EASY	F1	T1	
		Dakar	F1	T1	
	PN7	DAKAR EVO	F1	T1	
		DAKAR UP	F1	T1	
		DAKAR EASY	F1	T1	
		Dakar	F1	T1	
		Dakar Express	F1	T1	
	PREFER®	P15	DAKAR EVO	F1	T1
DAKAR UP			F1	T1	
DAKAR EASY			F1	T1	
Dakar			F1	T1	
Dakar Express			F1	T1	
P16		DAKAR EVO	F1	T1	
		DAKAR UP	F1	T1	
		DAKAR EASY	F1	T1	
		Dakar	F1	T1	
		Dakar Express	F1	T1	
P17	DAKAR EVO	F1	T1		
	DAKAR UP	F1	T1		
	DAKAR EASY	F1	T1		
	Dakar	F1	T1		
	Dakar Express	F1	T1		
ROSSETTI®	ROS1	DAKAR EVO	F1	T1	
		DAKAR UP	F1	T1	
		DAKAR EASY	F1	T1	
		Dakar	F1	T1	
		Dakar Express	F1	T1	



SEA®	SE1L	DAKAR EVO	F3	T3	
			F20	T20	
		DAKAR UP	F3	T3	
			F20	T20	
		DAKAR EASY	F3	T3	
			F20	T20	
		Dakar	F3	T3	
			F20	T20	
		Dakar Express	F3	T3	
			F20	T20	
SECUREMME®	SEM7	DAKAR EVO	F5	T5	
		DAKAR UP	F5	T5	
		DAKAR EASY	F5	T5	
		Dakar	F5	T5	
		Dakar Express	F5	T5	
	SEM8	DAKAR EVO	F5	T5	
		DAKAR UP	F5	T5	
		DAKAR EASY	F5	T5	
		Dakar	F5	T5	
		Dakar Express	F5	T5	
SEM8P	DAKAR EVO	F5	T5		
	DAKAR UP	F5	T5		
	DAKAR EASY	F5	T5		
	Dakar	F5	T5		
	Dakar Express	F5	T5		
SEM10P	DAKAR EVO	F5	T5		
	DAKAR UP	F5	T5		
	DAKAR EASY	F5	T5		
	Dakar	F5	T5		
	Dakar Express	F5	T5		
SECURITAL®	SCU1	DAKAR EVO	F20	T20	
		DAKAR UP	F20	T20	
		DAKAR EASY	F20	T20	
		Dakar	F20	T20	
		Dakar Express	F20	T20	
	SCU2	DAKAR EVO	F20	T20	
		DAKAR UP	F20	T20	
		DAKAR EASY	F20	T20	
		Dakar	F20	T20	
		Dakar Express	F20	T20	
SMART®	T00SMR1P	DAKAR EVO	F11	T11	
		DAKAR UP	F11	T11	



FOR:	ERREBI	Smart	Spider	STS	
SMART®	T00SMR1P	DAKAR EASY	F11	T11	
		Dakar	F11	T11	
		Dakar Express	F11	T11	
SPIDER®	SPR2	DAKAR EVO	F1	T1	
		DAKAR UP	F1	T1	
		DAKAR EASY	F1	T1	
		Dakar	F1	T1	
		Dakar Express	F1	T1	
STS®	ORIGINAL ST6	DAKAR EVO	F23	T23	
		DAKAR UP	F23	T23	
		DAKAR EASY	F23	T23	
		Dakar	F23	T23	
		Dakar Express	F23	T23	
	ORIGINAL ST15	DAKAR EVO	F23	T23	
		DAKAR UP	F23	T23	
		DAKAR EASY	F23	T23	
		Dakar	F23	T23	
		Dakar Express	F23	T23	
	STS1N	DAKAR EVO	F1	T1	
		DAKAR UP	F1	T1	
		DAKAR EASY	F1	T1	
		Dakar	F1	T1	
		Dakar Express	F1	T1	
	STS1NR	DAKAR EVO	F1	T1	
		DAKAR UP	F1	T1	
		DAKAR EASY	F1	T1	
		Dakar	F1	T1	
		Dakar Express	F1	T1	
	STS5	DAKAR EVO	F5	T5	
		DAKAR UP	F5	T5	
		DAKAR EASY	F5	T5	
		Dakar	F5	T5	
		Dakar Express	F5	T5	
	STS10	DAKAR EVO	F5	T5	
		DAKAR UP	F5	T5	AD-ST5
		DAKAR EASY	F5	T5	AD-ST5
		Dakar	F5	T5	
		Dakar Express	F5	T5	AD-ST5
	STS11	DAKAR EVO	F5	T5	
		DAKAR UP	F5	T5	AD-ST5
		DAKAR EASY	F5	T5	AD-ST5
Dakar		F5	T5		
Dakar Express		F5	T5	AD-ST5	
STS12	DAKAR EVO	F1	T1		



FOR:	ERREBI	STS	Subaru	Taroni	Tecsesa	Tesa
STS®	STS12	DAKAR UP	F1	T1		
		DAKAR EASY	F1	T1		
		Dakar	F1	T1		
		Dakar Express	F1	T1		
		DAKAR EVO	F1	T1		
	STS15	DAKAR UP	F1	T1		
		DAKAR EASY	F1	T1		
		Dakar	F1	T1		
		Dakar Express	F1	T1		
		DAKAR EVO	F1	T1		
		DAKAR UP	F1	T1		
SUBARU®	SUB1P175	DAKAR EVO	F11	T11		
		DAKAR UP	F11	T11		
		DAKAR EASY	F11	T11		
		Dakar	F11	T11		
		Dakar Express	F11	T11		
TARONI®	T7	DAKAR EVO	F1	T1		
		DAKAR UP	F1	T1		
		DAKAR EASY	F1	T1		
		Dakar	F1	T1		
		Dakar Express	F1	T1		
	T8	DAKAR EVO	F1	T1		
		DAKAR UP	F1	T1		
		DAKAR EASY	F1	T1		
		Dakar	F1	T1		
		Dakar Express	F1	T1		
T8R	DAKAR EVO	F1	T1			
	DAKAR UP	F1	T1			
	DAKAR EASY	F1	T1			
	Dakar	F1	T1			
	Dakar Express	F1	T1			
T10	DAKAR EVO	F1	T1			
	DAKAR UP	F1	T1			
	DAKAR EASY	F1	T1			
	Dakar	F1	T1			
	Dakar Express	F1	T1			
TECSESA®	TCS1	DAKAR EVO	F5	T5		
		DAKAR UP	F5	T5		
		DAKAR EASY	F5	T5		
		Dakar	F5	T5		
		Dakar Express	F5	T5		
TESA®	TS12	DAKAR EVO	F5	T5		
		DAKAR UP	F5	T5		
		DAKAR EASY	F5	T5		
	TS12	Dakar	F5	T5		
		Dakar Express	F5	T5		
		DAKAR EVO	F5	T5		

FOR:



TESA®

TS14	DAKAR UP	F5	T5	
	DAKAR EASY	F5	T5	
	Dakar	F5	T5	
	Dakar Express	F5	T5	
TS15	DAKAR EVO	F5	T5	
	DAKAR UP	F5	T5	
	DAKAR EASY	F5	T5	
	Dakar	F5	T5	
Dakar Express	F5	T5		
	F5	T5		
	F5	T5		
	F5	T5		
TS18	DAKAR EVO	F5	T5	
	DAKAR UP	F5	T5	
	DAKAR EASY	F5	T5	
	Dakar	F5	T5	
Dakar Express	F5	T5		
	F5	T5		
	F5	T5		
	F5	T5		
TS19	DAKAR EVO	F5	T5	
	DAKAR UP	F5	T5	
	DAKAR EASY	F5	T5	
	Dakar	F5	T5	
Dakar Express	F5	T5		
	F5	T5		
	F5	T5		
	F5	T5		
TS20	DAKAR EVO	F5	T5	
	DAKAR UP	F5	T5	
	DAKAR EASY	F5	T5	
	Dakar	F5	T5	
Dakar Express	F5	T5		
	F5	T5		
	F5	T5		
	F5	T5		
TS21	DAKAR EVO	F5	T5	
	DAKAR UP	F5	T5	
	DAKAR EASY	F5	T5	
	Dakar	F5	T5	
Dakar Express	F5	T5		
	F5	T5		
	F5	T5		
	F5	T5		
T00TB1P	DAKAR EVO	F22-3T	T22	AD-TB
	DAKAR UP	F22-3T	T22	AD-TB
	DAKAR EASY	F22-3T	T22	AD-TB
	Dakar	F22-3T	T22	AD-TB
Dakar Express	F22-3T	T22	AD-BT	
	F22-3T	T22	AD-TB	
	F22-3T	T22	AD-TB	
	F22-3T	T22	AD-TB	
T00TB1PA	DAKAR EVO	F22-3T	T22	AD-TB
	DAKAR UP	F22-3T	T22	AD-TB
	DAKAR EASY	F22-3T	T22	AD-TB
	Dakar	F22-3T	T22	AD-TB
Dakar Express	F22-3T	T22	AD-TB	
	F22-3T	T22	AD-TB	
	F22-3T	T22	AD-TB	
	F22-3T	T22	AD-TB	
T00TB1PB	DAKAR EVO	F22-3T	T22	AD-TB
	DAKAR UP	F22-3T	T22	AD-TB
	DAKAR EASY	F22-3T	T22	AD-TB
	Dakar	F22-3T	T22	AD-TB
Dakar Express	F22-3T	T22	AD-TB	
	F22-3T	T22	AD-TB	
	F22-3T	T22	AD-TB	
	F22-3T	T22	AD-TB	





TIBBE®





FOR:



TIBBE®

T00TB2P	DAKAR EVO	F22-3T	T22	AD-TB
	DAKAR UP	F22-3T	T22	AD-TB
	DAKAR EASY	F22-3T	T22	AD-TB
	Dakar	F22-3T	T22	AD-TB
Dakar Express	F22-3T	T22	AD-TB	
	F22-3T	T22	AD-TB	
	F22-3T	T22	AD-TB	
	F22-3T	T22	AD-TB	
T00TB4P	DAKAR EVO	F22-3T	T22	AD-TB
	DAKAR UP	F22-3T	T22	AD-TB
	DAKAR EASY	F22-3T	T22	AD-TB
	Dakar	F22-3T	T22	AD-TB
Dakar Express	F22-3T	T22	AD-TB	
	F22-3T	T22	AD-TB	
	F22-3T	T22	AD-TB	
	F22-3T	T22	AD-TB	
TB1P5	DAKAR EVO	F22-3T	T22	AD-TB
	DAKAR UP	F22-3T	T22	AD-TB
	DAKAR EASY	F22-3T	T22	AD-TB
	Dakar	F22-3T	T22	AD-TB
Dakar Express	F22-3T	T22	AD-TB	
	F22-3T	T22	AD-TB	
	F22-3T	T22	AD-TB	
	F22-3T	T22	AD-TB	
TB2P96	DAKAR EVO	F22-3T	T22	AD-TB
	DAKAR UP	F22-3T	T22	AD-TB
	DAKAR EASY	F22-3T	T22	AD-TB
	Dakar	F22-3T	T22	AD-TB
Dakar Express	F22-3T	T22	AD-TB	
	F22-3T	T22	AD-TB	
	F22-3T	T22	AD-TB	
	F22-3T	T22	AD-TB	
TILANCO®	TLC1R	DAKAR EVO	F19	T19
	DAKAR UP	F19	T19	
	DAKAR EASY	F19	T19	
	Dakar	F19	T19	
Dakar Express	F19	T19		
	F19	T19		
	F19	T19		
	F19	T19		
TITAN®	TT13	DAKAR EVO	F5	T5
	DAKAR UP	F5	T5	
	DAKAR EASY	F5	T5	
	Dakar	F5	T5	
Dakar Express	F5	T5		
	F5	T5		
	F5	T5		
	F5	T5		
TT20	DAKAR EVO	F5	T5	
	DAKAR UP	F5	T5	
	DAKAR EASY	F5	T5	
	Dakar	F5	T5	
Dakar Express	F5	T5		
	F5	T5		
	F5	T5		
	F5	T5		
TT22	DAKAR EVO	F5	T5	
	DAKAR UP	F5	T5	
	DAKAR EASY	F5	T5	
	Dakar	F5	T5	
Dakar Express	F5	T5		
	F5	T5		
	F5	T5		
	F5	T5		
TT25R	DAKAR EVO	F6	T6	
	DAKAR UP	F6	T6	
	DAKAR EASY	F6	T6	
	Dakar	F6	T6	
Dakar Express	F6	T6		
	F6	T6		
	F6	T6		
	F6	T6		

FOR:					
TITAN®	TT26	DAKAR EVO	F5	T5	
		DAKAR UP	F5	T5	
		DAKAR EASY	F5	T5	
		Dakar	F5	T5	
		Dakar Express	F5	T5	
	TT27	DAKAR EVO	F5	T5	
		DAKAR UP	F5	T5	
		DAKAR EASY	F5	T5	
		Dakar	F5	T5	
		Dakar Express	F5	T5	
	TT28	DAKAR EVO	F5	T5	
		DAKAR UP	F5	T5	
		DAKAR EASY	F5	T5	
		Dakar	F5	T5	
		Dakar Express	F5	T5	
	TOK-TRELOCK®	TK41P	DAKAR EVO	F11	T11
DAKAR UP			F11	T11	
DAKAR EASY			F11	T11	
Dakar			F11	T11	
Dakar Express			F11	T11	
TOVER®	TOV1	DAKAR EVO	F1	T1	
		DAKAR UP	F1	T1	
		DAKAR EASY	F1	T1	
		Dakar	F1	T1	
		Dakar Express	F1	T1	
	TOV2	DAKAR EVO	F1	T1	
		DAKAR UP	F1	T1	
		DAKAR EASY	F1	T1	
		Dakar	F1	T1	
		Dakar Express	F1	T1	
	TOV4	DAKAR EVO	F1	T1	
		DAKAR UP	F1	T1	
		DAKAR EASY	F1	T1	
		Dakar	F1	T1	
		Dakar Express	F1	T1	
	TOV5	DAKAR EVO	F1	T1	
		DAKAR UP	F1	T1	
		DAKAR EASY	F1	T1	
		Dakar	F1	T1	
		Dakar Express	F1	T1	
	TOV8	DAKAR EVO	F1	T1	
		DAKAR UP	F1	T1	
		DAKAR EASY	F1	T1	
		Dakar	F1	T1	







FOR:					
TOVER®	TOV8	Dakar Express	F1	T1	
TOYOTA®	T00TY43P	DAKAR EVO	F17	T17	
		DAKAR UP	F17	T17	
		DAKAR EASY	F17	T17	
		Dakar	F17	T17	
		Dakar Express	F17	T17	
	T00TY47P	DAKAR EVO	F17	T17	
		DAKAR UP	F17	T17	
		DAKAR EASY	F17	T17	
		Dakar	F17	T17	
		Dakar Express	F17	T17	
	T00TY48P	DAKAR EVO	F17	T17	
		DAKAR UP	F17	T17	
		DAKAR EASY	F17	T17	
		Dakar	F17	T17	
		Dakar Express	F17	T17	
	TOYOTA®	T00TY48P	DAKAR EVO	F17	T17
DAKAR UP			F17	T17	
DAKAR EASY			F17	T17	
Dakar			F17	T17	
Dakar Express			F17	T17	
TY43P80	DAKAR EVO	F17	T17		
	DAKAR UP	F17	T17		
	DAKAR EASY	F17	T17		
	Dakar	F17	T17		
	Dakar Express	F17	T17		
UCEM®	UE7R	DAKAR EVO	F13	T13	
		DAKAR UP	F13	T13	
		DAKAR EASY	F13	T13	
		Dakar	F13	T13	
		Dakar Express	F13	T13	
	UE8R	DAKAR EVO	F13	T13	
		DAKAR UP	F13	T13	
		DAKAR EASY	F13	T13	
		Dakar	F13	T13	
		Dakar Express	F13	T13	
	UE9	DAKAR EVO	F14	T14	
		DAKAR UP	F14	T14	
		DAKAR EASY	F14	T14	
		Dakar	F14	T14	
		Dakar Express	F14	T14	
	UE9R	DAKAR EVO	F14	T14	
DAKAR UP		F14	T14		
DAKAR EASY		F14	T14		
Dakar		F14	T14		
Dakar Express		F14	T14		
UE12R	DAKAR EVO	F13	T13		
	DAKAR UP	F13	T13		
	DAKAR EASY	F13	T13		
	Dakar	F13	T13		









UCEM®	UE12R	Dakar Express	F13	T13	
	UE14	DAKAR EVO	F13	T13	
		DAKAR UP	F13	T13	
		DAKAR EASY	F13	T13	
		Dakar	F13	T13	
		Dakar Express	F13	T13	
URBIS®	URB1	DAKAR EVO	F1	T1	
		DAKAR UP	F1	T1	
		DAKAR EASY	F1	T1	
		Dakar	F1	T1	
		Dakar Express	F1	T1	
VACHETTE®	ORIGINAL VRX	DAKAR EVO	F1	T1	AD-VAX
		DAKAR UP	F1	T1	AD-VAX
		DAKAR EASY	F1	T1	AD-VAX
		Dakar	F1	T1	AD-VAX
		Dakar Express	F1	T1	AD-VAX
	VC15	DAKAR EVO	F21	T21	30°
		Dakar	F21	T21	30°
	VC80LPP	DAKAR EVO	F21	T21	19°
		DAKAR UP	F21	T21	AD-VA
		DAKAR EASY	F21	T21	AD-VA
		Dakar	F21	T21	19°
		Dakar Express	F21	T21	AD-VA
	VC87	DAKAR EVO	F1	T1	
		DAKAR UP	F1	T1	
		DAKAR EASY	F1	T1	
		Dakar	F1	T1	
		Dakar Express	F1	T1	
	VC89	DAKAR EVO	F1	T1	
		DAKAR UP	F1	T1	
		DAKAR EASY	F1	T1	
Dakar		F1	T1		
Dakar Express		F1	T1		
VALEO®	T00VA1P	DAKAR EVO	F11	T11	
		DAKAR UP	F11	T11	
		DAKAR EASY	F11	T11	
		Dakar	F11	T11	
		Dakar Express	F11	T11	
	VA1C1	DAKAR EVO	F11	T11	
		DAKAR UP	F11	T11	
		DAKAR EASY	F11	T11	
		Dakar	F11	T11	
		Dakar Express	F11	T11	
	VA1P	DAKAR EVO	F11	T11	



VALEO®	VA1P	DAKAR UP	F11	T11	
		DAKAR EASY	F11	T11	
		Dakar	F11	T11	
		Dakar Express	F11	T11	
VEROFER®	VF1	DAKAR EVO	F19	T19	
		DAKAR UP	F19	T19	
		DAKAR EASY	F19	T19	
		Dakar	F19	T19	
VIRO®	V15	DAKAR EVO	F5	T5	
		DAKAR UP	F5	T5	
		DAKAR EASY	F5	T5	
		Dakar	F5	T5	
WALLY®	W13	DAKAR EVO	F1	T1	
		DAKAR UP	F1	T1	
		DAKAR EASY	F1	T1	
		Dakar	F1	T1	
WANJIN®	WAN1R	DAKAR EVO	F5	T5	
		DAKAR UP	F5	T5	
		DAKAR EASY	F5	T5	
		Dakar	F5	T5	
WILKA®	W1100	DAKAR EVO	F1	T1	
		DAKAR UP	F1	T1	
		DAKAR EASY	F1	T1	
		Dakar	F1	T1	
WINKHAUS®	ORIGINAL X-TRA	DAKAR EVO	F13	T13	15°
		Dakar	F13	T13	15°
	TK23	DAKAR EVO	F15	T15	
		DAKAR UP	F15	T15	P-WIN
		DAKAR EASY	F15	T15	P-WIN
		Dakar	F15	T15	P-WIN
	TK23R	DAKAR EVO	F15	T15	
		DAKAR UP	F15	T15	P-WIN
		DAKAR EASY	F15	T15	P-WIN
		Dakar	F15	T15	P-WIN
	TK25	DAKAR EVO	F15	T15	
		DAKAR UP	F15	T15	P-WIN
		DAKAR EASY	F15	T15	P-WIN
		Dakar	F15	T15	P-WIN

FOR:						
WINKHAUS®	TK25	Dakar Express	F15	T15	P-WIN	
WT®	WT1	DAKAR EVO	BF3-3T	T3		
		DAKAR UP	BF3-3T	T3		
		DAKAR EASY	BF3-3T	T3		
		Dakar	BF3-3T	T3		
		Dakar Express	BF3-3T	T3		
YALE®	Y118	DAKAR EVO	F19	T19		
		DAKAR UP	F19	T19		
		DAKAR EASY	F19	T19		
		Dakar	F19	T19		
	Y118	Dakar	F19	T19		
		Dakar Express	F19	T19		
	Y119	DAKAR EVO	F5	T5		
		DAKAR UP	F5	T5		
		DAKAR EASY	F5	T5		
		Dakar	F5	T5		
		Dakar Express	F5	T5		
	Y120	DAKAR EVO	F1	T1		
		DAKAR UP	F1	T1		
		DAKAR EASY	F1	T1		
		Dakar	F1	T1		
		Dakar Express	F1	T1		
	Y121	DAKAR EVO	F5	T5		
		DAKAR UP	F5	T5		
		DAKAR EASY	F5	T5		
		Dakar	F5	T5		
		Dakar Express	F5	T5		
Y124	DAKAR EVO	F19	T19			
	DAKAR UP	F19	T19			
	DAKAR EASY	F19	T19			
	Dakar	F19	T19			
	Dakar Express	F19	T19			
YALE-GB®	YG19	DAKAR EVO	F19	T19	14°	
		DAKAR EVO	F3	T3		
		Dakar	F19	T19	14°	
		Dakar	F3	T3		
YARDENI®	YR1R	DAKAR EVO	F1	T1		
		DAKAR UP	F1	T1		
		DAKAR EASY	F1	T1		
		Dakar	F1	T1		
		Dakar Express	F1	T1		
	YR2R	DAKAR EVO	F13	T13		
		DAKAR UP	F13	T13		
		DAKAR EASY	F13	T13		
		Dakar	F13	T13		

FOR:							
YARDENI®	YR2R	Dakar Express	F13	T13			
	YR4R	DAKAR EVO	F13	T13			
		DAKAR UP	F13	T13			
		DAKAR EASY	F13	T13			
		Dakar	F13	T13			
		Dakar Express	F13	T13			
	YR5R	DAKAR EVO	F13	T13			
		DAKAR UP	F13	T13			
	YR5R	DAKAR EASY	F13	T13			
		Dakar	F13	T13			
		Dakar Express	F13	T13			
	YETI-PL®	YE17	DAKAR EVO	F5	T5		
			DAKAR UP	F5	T5		
			DAKAR EASY	F5	T5		
			Dakar	F5	T5		
		Dakar Express	F5	T5			
YMOS®	T00YM22P	DAKAR EVO	F17	T17	AD-OP		
		DAKAR UP	F17	T17	AD-OP		
		DAKAR EASY	F17	T17	AD-OP		
		Dakar	F17	T17	AD-OP		
		Dakar Express	F17	T17	AD-OP		
	T00YM30P	DAKAR EVO	F11	T11			
		DAKAR UP	F11	T11			
		DAKAR EASY	F11	T11			
		Dakar	F11	T11			
		Dakar Express	F11	T11			
	YM22P15	DAKAR EVO	F17	T17	AD-OP		
		DAKAR UP	F17	T17	AD-OP		
		DAKAR EASY	F17	T17	AD-OP		
		Dakar	F17	T17	AD-OP		
		Dakar Express	F17	T17	AD-OP		
	YM26RP147	DAKAR EVO	F17	T17	AD-SA		
		DAKAR UP	F17	T17	AD-SA		
		DAKAR EASY	F17	T17	AD-SA		
		Dakar	F17	T17	AD-SA		
		Dakar Express	F17	T17	AD-SA		
	YM28P17	DAKAR EVO	F11	T11	AD-MM		
	DAKAR UP	F11	T11	AD-MM			
	DAKAR EASY	F11	T11	AD-MM			
	Dakar	F11	T11	AD-MM			
	Dakar Express	F11	T11	AD-MM			
YM30P	DAKAR EVO	F11	T11				
	DAKAR UP	F11	T11				
	DAKAR EASY	F11	T11				

FOR:



YMOS®

YM30P	Dakar	F11	T11
	Dakar Express	F11	T11

ZADI®

T00ZA21P	DAKAR EVO	BF3-3T	T3
	DAKAR UP	BF3-3T	T3
	DAKAR EASY	BF3-3T	T3
	Dakar	BF3-3T	T3
	Dakar Express	BF3-3T	T3
ZA15	DAKAR EVO	F5	T5
	DAKAR UP	F5	T5
	DAKAR EASY	F5	T5
	Dakar	F5	T5
	Dakar Express	F5	T5
ZA20	DAKAR EVO	BF3-3T	T3
	DAKAR UP	BF3-3T	T3
	DAKAR EASY	BF3-3T	T3
	Dakar	BF3-3T	T3
	Dakar Express	BF3-3T	T3

MACCHINE MECCANICHE

MECHANISCHE MASCHINEN
MECHANICAL MACHINES
MACHINES MECANIQUES



PER CHIAVI A CILINDRO

FÜR ZYLINDERSCHLÜSSEL

FOR FLAT KEYS

POUR CLES PLATES

ALASKA - ERREBI 5 - ALFA PLUS - MICRO

ERREBI[®]



PER CHIAVI A CILINDRO FÜR ZYLINDERSCHLÜSSEL - FOR FLAT KEYS - POUR CLES PLATES

ALASKA



La ALASKA è la macchina semiautomatica per copiare chiavi piatte per serrature a cilindro e per veicoli, chiavi a croce e speciali, disegnata per i professionisti della duplicazione. La ALASKA è dotata di un innovativo sistema elettronico che facilita la taratura anche per i meno esperti.

ALASKA is the semi automatic key cutting machine for cylinder, vehicle and cruciform keys, designed for key duplicating professionals. ALASKA has an innovative electronic system for easy adjustment of the machine that makes the operation easy even for beginners.

ALASKA, die halbautomatische Schlüsselkopierfräse für Zylinder-, Fahrzeug- und Kreuzschlüssel, entworfen für Profis der Schlüsselkopierbranche. Die ALASKA hat ein innovatives elektronisches System für die einfache Justierung der Maschine, was auch gerade für Anfänger die Bedienung erleichtert.

ALASKA est une machine semi-automatique de précision pour les clés plates et véhicules, cruciformes et spéciaux. Avec son nouveau système de réglage électronique permet un usage simple et de précision.

ERREBI 5



ERREBI 5 è la macchina semiautomatica per copiare chiavi piatte per serrature a cilindro e per veicoli, chiavi a croce e speciali, compatta e professionale che combina semplicità e versatilità. Tecnologia e materiali di ultima generazione la rendono una macchina resistente e precisa nella duplicazione.

ERREBI 5 is the semiautomatic key cutting machine for cylinder, vehicle and cruciform keys. It is a compact and professional machine that combines simplicity and versatility. New technology and last generation materials make it resistant and precise duplicating machine.

ERREBI-5, die halbautomatische Schlüsselkopierfräse für Zylinder-, Fahrzeug und Kreuzschlüssel. Die kompakte Bauweise dieser professionellen Maschine vereint Einfachheit und Präzision.

ERREBI 5 est une machine semi-automatique pour les clés plates et véhicules, cruciformes et spéciaux. C'est une machine compacte et professionnelle qui combine simplicité et précision. La technologie des matériaux de dernière génération la rend résistante et précise.

ALFA PLUS



ALFA PLUS è la macchina semi automatica per copiare chiavi piatte per serrature a cilindro e per veicoli, chiavi a croce e speciali. La fresa inserita direttamente nell'albero motore e il morsetto a quattro lati la rendono semplice e precisa nella copia.

ALFA PLUS is the semiautomatic key cutting machine for cylinder, vehicle and cruciform keys. Its cutter is directly fitted to the motor axle and in combination with a four sides clamp make this machine easy and precise in copying.

ALFA PLUS ist eine halbautomatische Schlüsselkopierfräse für Zylinder-, Fahrzeug- und Kreuzschlüssel. Durch die Montage des Fräasers direkt auf der Motorachse in Kombination mit einer Vierfach-Spannbacke macht diese Maschine die Schlüsselkopie einfach und präzise.

ALFA PLUS est une machine pour les clés plates et véhicules, cruciformes et spéciaux. C'est une machine simple sans perdre la précision dans la reproduction. La fraise fixée directement dans l'arbre de transmission et l'étai à quatre faces fait de cette machine une simplicité et une précision.

MICRO



La nuova macchina MICRO di Errebi è maneggevole e versatile nel suo servizio di duplicazione chiavi. Leggera e compatta MICRO è perfetta per duplicare chiavi piatte, chiavi auto e chiavi a croce in qualunque spazio, anche nei veicoli.

The new Errebi MICRO key duplicating machine offers a compact design with the mobile locksmith in mind. The MICRO precision, lightweight and compact design delivers a high quality duplication service.

MICRO ist die neue Maschine von Errebi, die Schlüssel im Handumdrehen dupliziert. Leicht und kompakt ist MICRO das perfekte Werkzeug zum Duplizieren von Flachschlüsseln und zwar überall, selbst in Fahrzeugen.

La nouvelle machine MICRO de Errebi garantit une polyvalence totale dans votre service de reproduction de clés. Légère et très compacte, MICRO est l'outil parfait pour reproduire des clés plates dans tous les espaces, y compris dans des véhicules.



FRESE - FRÄSER - CUTTERS - FRAISES

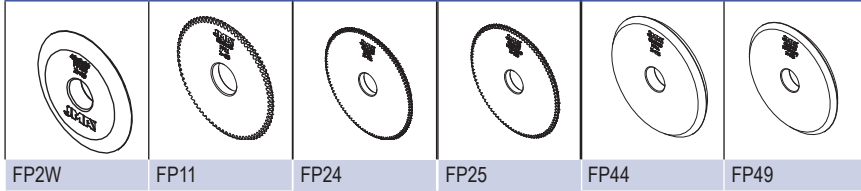

Codice	AxBxC	D	E	Tastatore	PER-FOR	MAT
FP2W	40x6x10	35	0,1		Epsilon	W
FP11	63x5x16	42	0,1		MICRO-ALFA PLUS-Alfa-Alfa Matic	HSS
FP11T	63x5x16	42	0,1		MICRO-ALFA PLUS-Alfa-Alfa Matic	HSS-TiCN
FP24	80x5x16 Z110	42	0,15		ALASKA-ERREBI 5-Errebi 4-Errebi 4 Plus	HSS
FP24T	80x5x16 Z110	42	0,15		ALASKA-ERREBI 5-Errebi 4-Errebi 4 Plus	HSS-TiCN
FP24W	80x5x16 Z110	42	0,15		ALASKA-ERREBI 5-Errebi 4-Errebi 4 Plus	W
FP25	80x5x16 Z118	42,3	0,15		ALASKA-ERREBI 5-Errebi 4-Errebi 4 Plus	HSS
FP44	80x8x16	52,5	0,15	T84	ALASKA-ERREBI 5	HSS
FP49	80x8x16	45	0,4	T83	ALASKA-ERREBI 5	HSS

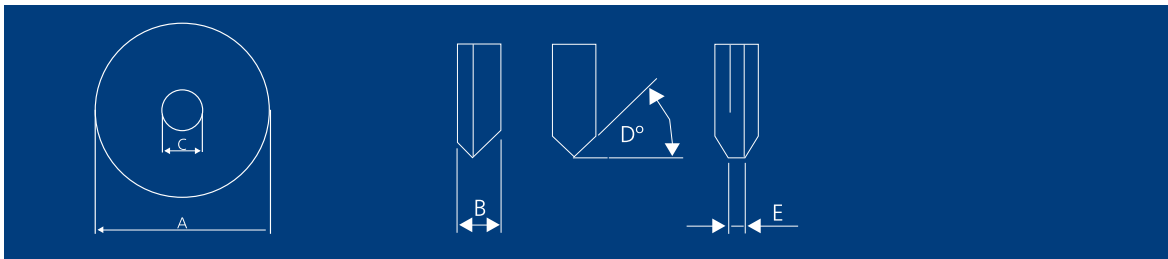

SIMBOLI - SYMBOLIK - SYMBOLS



MACCHINA PER CHIAVI A CILINDRO
MASCHINE FÜR ZYLINDERSCHLÜSSEL
MACHINES FOR FLAT KEYS
MACHINES POUR CLES PLATES



ADATTATORI
ADAPTER
ADAPTORS
ADAPTEURS



Angolo di taglio
Schnittwinkel
Cutting angle
Angle de coupe



Diametro interno
Durchmesser Aufnahme
Internal diameter
Alésage



FRESE
FRÄSER
CUTTERS
FRAISES



HSS
Acciaio Super rapido
Schnellarbeitsstahl
High-speed steel
Acier extra rapide



Spessore
Stärke
Thickness
Épaisseur



TASTATORI
TASTER
TRACERS
PALPEURS



Pianetto angolo di taglio
Schnittwinkel Aussenkante
Flat part cutting angle
Partie plate angle de coupe



Diametro esterno
Durchmesser
External diameter
Diamètre extérieur



TASTATORI - TASTER - TRACERS - PALPEURS

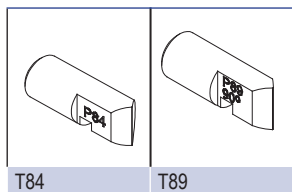

T84

T89



ADATTATORI - ADAPTER - ADAPTORS - ADAPTEURS

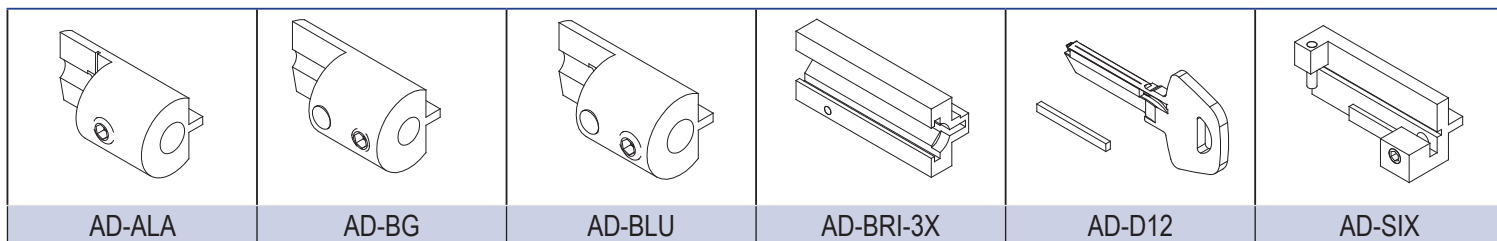

AD-ALA

AD-BG

AD-BLU

AD-BRI-3X

AD-D12

AD-SIX

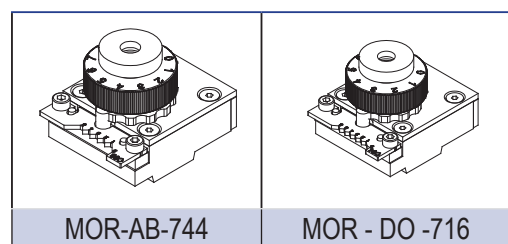

MOR-AB-744

MOR-DO-716

ADATTATORE	ALASKA	ERREBI 5	ALFA	ALFA PLUS	Epsilon	Alfa Matic	Errebi 4	Errebi 4 Plus
AD-ALA	X	X	X	X	X	X	X	X
AD-BG	X	X	X	X	X	X	X	X
AD-BLU	X	X	X	X	X	X	X	X
AD-BRI-3X	X	X	X	X	X	X	X	X
AD-D12	X	X	X	X	X	X	X	X
AD-SIX	X	X	X	X	X	X	X	X
MOR-AB-744	X	X						
MOR-DO-716	X	X						

GUIDA ALLA DUPLICAZIONE

DATENBLATT FÜR FACHLEUTE
SPECIALIST FILE
FICHE SPÉCIALISÉE







PER CHIAVI A CILINDRO

FÜR ZYLINDERSCHLÜSSEL
FOR FLAT KEYS
POUR CLES PLATES

ALASKA - ERREBI 5 - ALFA PLUS - MICRO

ERREBI®

FOR:					
ABUS®	ORIGINAL XP/SP	ALASKA	FP44	T84	MOR-AB-744
		ERREBI 5	FP44	T84	MOR-AB-744
ALA®	ALX1	ALASKA			AD-ALA
		ERREBI 5			AD-ALA
		ALFA			AD-ALA
		ALFA PLUS			AD-ALA
		MICRO			AD-ALA
		Alfa Matic			AD-ALA
		Epsilon			AD-ALA
		Errebi 4			AD-ALA
		Errebi 4 Plus			AD-ALA
ASSA®	ORIGINAL D12	ALASKA			AD-D12
		ERREBI 5			AD-D12
		ALFA			AD-D12
		ALFA PLUS			AD-D12
		Alfa Matic			AD-D12
		Epsilon			AD-D12
		Errebi 4			AD-D12
Errebi 4 Plus			AD-D12		
BLUMA®	BLUX1	ALASKA			AD-BLU
		ERREBI 5			AD-BLU
		ALFA			AD-BLU
		ALFA PLUS			AD-BLU
		MICRO			AD-BLU
		Alfa Matic			AD-BLU
		Epsilon			AD-BLU
		Errebi 4			AD-BLU
Errebi 4 Plus			AD-BLU		
BRICARD®	BD710	ALASKA			AD-BRI-3X
		ERREBI 5			AD-BRI-3X
		ALFA			AD-BRI-3X
		ALFA PLUS			AD-BRI-3X
		MICRO			AD-BRI-3X
		Alfa Matic			AD-BRI-3X
		Epsilon			AD-BRI-3X
		Errebi 4			AD-BRI-3X
	BD720	ALASKA			AD-BRI-3X
		ERREBI 5			AD-BRI-3X
		ALFA			AD-BRI-3X
		ALFA PLUS			AD-BRI-3X

FOR:					
BRICARD®	BD720	MICRO			AD-BRI-3X
		Alfa Matic			AD-BRI-3X
		Epsilon			AD-BRI-3X
		Errebi 4			AD-BRI-3X
		Errebi 4 Plus			AD-BRI-3X
	BD730	ALASKA			AD-BRI-3X
		ERREBI 5			AD-BRI-3X
		ALFA			AD-BRI-3X
		ALFA PLUS			AD-BRI-3X
		MICRO			AD-BRI-3X
		Alfa Matic			AD-BRI-3X
		Epsilon			AD-BRI-3X
		Errebi 4			AD-BRI-3X
		Errebi 4 Plus			AD-BRI-3X
BD740	ALASKA			AD-BRI-3X	
	ERREBI 5			AD-BRI-3X	
	ALFA			AD-BRI-3X	
	ALFA PLUS			AD-BRI-3X	
	MICRO			AD-BRI-3X	
	Alfa Matic			AD-BRI-3X	
	Epsilon			AD-BRI-3X	
	Errebi 4			AD-BRI-3X	
	Errebi 4 Plus			AD-BRI-3X	
BD750	ALASKA			AD-BRI-3X	
	ERREBI 5			AD-BRI-3X	
	ALFA			AD-BRI-3X	
	ALFA PLUS			AD-BRI-3X	
	MICRO			AD-BRI-3X	
	Alfa Matic			AD-BRI-3X	
	Epsilon			AD-BRI-3X	
	Errebi 4			AD-BRI-3X	
	Errebi 4 Plus			AD-BRI-3X	
BD760	ALASKA			AD-BRI-3X	
	ERREBI 5			AD-BRI-3X	
	ALFA			AD-BRI-3X	
	ALFA PLUS			AD-BRI-3X	
	MICRO			AD-BRI-3X	
	Alfa Matic			AD-BRI-3X	
	Epsilon			AD-BRI-3X	
	Errebi 4			AD-BRI-3X	
	Errebi 4 Plus			AD-BRI-3X	
DOM®	DORMA-RS8	ALASKA	FP49	T89	MOR-DO-716



DOM®	DORMA-RS8	ERREBI 5	FP49	T89	MOR-DO-716	
	FIAM®	FY80	ALASKA			AD-BG
			ERREBI 5			AD-BG
			ALFA			AD-BG
			ALFA PLUS			AD-BG
			MICRO			AD-BG
			Alfa Matic			AD-BG
			Epsilon			AD-BG
			Errebi 4			AD-BG
			Errebi 4 Plus			AD-BG
FIAM-YALE®		FXT1	ALASKA			AD-BLU
	ERREBI 5				AD-BLU	
	ALFA				AD-BLU	
	ALFA PLUS				AD-BLU	
	MICRO				AD-BLU	
	Alfa Matic				AD-BLU	
	Epsilon				AD-BLU	
	Errebi 4				AD-BLU	
	Errebi 4 Plus				AD-BLU	
	FXT2	ALASKA			AD-BG	
		ERREBI 5			AD-BG	
		ALFA			AD-BG	
		ALFA PLUS			AD-BG	
		MICRO			AD-BG	
		Alfa Matic			AD-BG	
		Epsilon			AD-BG	
		Errebi 4			AD-BG	
		Errebi 4 Plus			AD-BG	
NEIMAN®	NE33P66	ALASKA			AD-NEVA	
		ERREBI 5			AD-NEVA	
		ALFA			AD-NEVA	
		ALFA PLUS			AD-NEVA	
		Alfa Matic			AD-NEVA	
		Epsilon			AD-NEVA	
		Errebi 4			AD-NEVA	
		Errebi 4 Plus			AD-NEVA	
		SIMPLEX®	SM7P68	ALASKA		
ERREBI 5					AD-SIX	
ALFA					AD-SIX	
ALFA PLUS					AD-SIX	
MICRO					AD-SIX	
Alfa Matic					AD-SIX	



SIMPLEX®	SM7P68	Epsilon			AD-SIX
		Errebi 4			AD-SIX
	SM7P74	Errebi 4 Plus			AD-SIX
		ALASKA			AD-SIX
		ERREBI 5			AD-SIX
		ALFA			AD-SIX
		ALFA PLUS			AD-SIX
		MICRO			AD-SIX
		Alfa Matic			AD-SIX
		Epsilon			AD-SIX
		Errebi 4			AD-SIX
	SM7P145	Errebi 4 Plus			AD-SIX
		ALASKA			AD-SIX
		ERREBI 5			AD-SIX
		ALFA			AD-SIX
		ALFA PLUS			AD-SIX
		MICRO			AD-SIX
		Alfa Matic			AD-SIX
		Epsilon			AD-SIX
		Errebi 4			AD-SIX
	T00SM7P	Errebi 4 Plus			AD-SIX
		ALASKA			AD-SIX
		ERREBI 5			AD-SIX
		ALFA			AD-SIX
		ALFA PLUS			AD-SIX
		MICRO			AD-SIX
		Alfa Matic			AD-SIX
		Epsilon			AD-SIX
		Errebi 4			AD-SIX
	Errebi 4 Plus			AD-SIX	

MACCHINE MECCANICHE

MECHANISCHE MASCHINEN

MECHANICAL MACHINES

MACHINES MECANIQUES

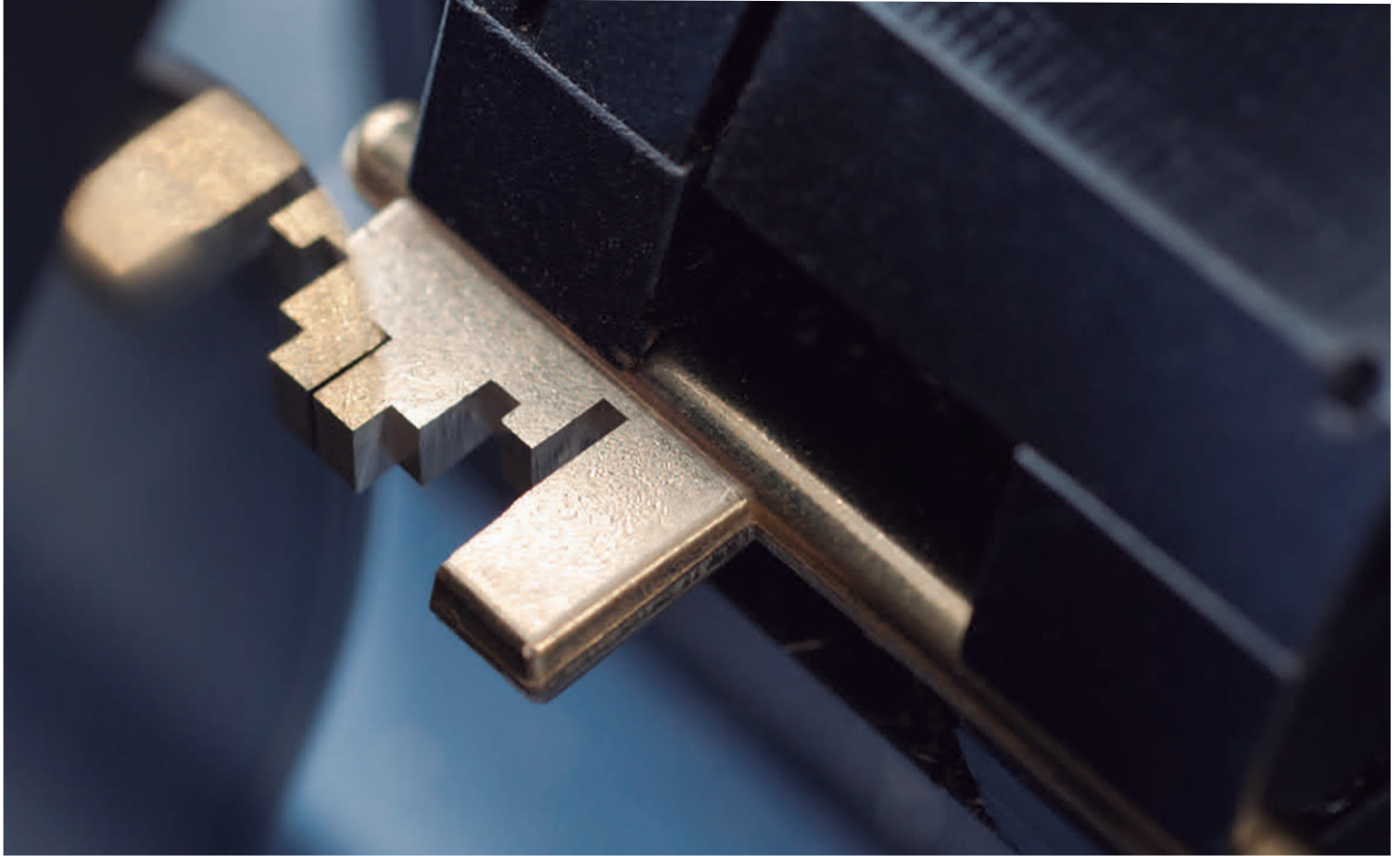

CHIAVI DOPPIA MAPPA, MAPPA SINGOLA E SPECIALI
FÜR DOPPELBARTSCHLÜSSEL, BARTSCHLÜSSEL UND SPEZIELLE SCHLÜSSEL
FOR BIT KEYS, DOUBLE BIT AND SPECIAL KEYS
POUR CLES À GORGES ET SPECIALES

**DELTA PROFESSIONAL - DELTA ADVANCE - ALFA BIT -
ALFA REGATA - ALFA FORD - ALFA ABLOY**

CERREBI®



PER CHIAVI DOPPIA MAPPA

FÜR BARTSCHLÜSSEL - FOR BIT KEYS - POUR CLES À GORGES



DELTA PROFESSIONAL

DELTA PROFESSIONAL è la macchina che permette -con un solo carrello- la duplicazione di chiavi a mappa singola e doppia, a pompa e a tagli verticali.

Dotata di un tastatore (intercambiabile) a regolazione micrometrica per una taratura precisa.

Con la medesima leva si possono fare i movimenti X e Y del carrello che appoggia su un piano a cuscinetti.

DELTA PROFESSIONAL is the machine for bit keys, both with single and double bits, frontal and vertical channel keys all on the same carriage. It has a tracer (interchangeable) with a micrometric adjustment for precision and using the same lever it makes X and Y movement of the carriage which is guided by bearing on rollers.

DELTA PROFESSIONAL ist die Maschine für Guß- und Tresorschlüssel, sowohl mit einfachen aber auch doppelten Einschnitten, sowohl für kopfseitige, als auch seitliche Fräsungen mit nur einem Schlitten. Der austauschbare Taster mit mikrometer-genauen Justierung für präzises Abtasten und exaktes Fräsen auf einem Schlitten mit in den Richtungen X und Y, der auf Rollenlager gleitet.

DELTA PROFESSIONAL est une machine qui permet avec un seul charriot la reproduction de clés à simple et double pannetons, à pompes et à taille frontale. Elle est fournie d'un palpeur (interchangeable) à régulation micrométrique pour un réglage précis. Par l'utilisation du même levier on peut faire les mouvements X et Y du chariot qui est monté sur un plateau à roulements.



DELTA ADVANCE

DELTA ADVANCE è la macchina di nuova generazione per la duplicazione di chiavi a mappa singola e doppia, a pompa e a tagli verticali. Dotata di morsetti disassati per la copia di chiavi particolarmente lunghe ed illuminazione a led.

DELTA ADVANCE is the machine for bit keys, both with single and double bits, frontal and vertical channel keys. It is equipped with off axis clamps for the copy of very long keys.

DELTA ADVANCE ist die Maschine für Guss- und Tresorschlüssel, sowohl für ein-, als auch für mehrseitige Schnitte, für kopfseitige oder seitliche Schnitte. Durch die Ausstattung mit achsfreien Spannbacken ist das Kopieren besonders langer Schlüssel möglich.

DELTA ADVANCE est une machine de nouvelle génération pour la reproduction de clés à simple et double pannetons à pompes et à taille frontale. Elle est fournie d'un étau décalé pour la duplication de clés très longues.



ALFA BIT

ALFA BIT è la macchina economica semi automatica per la duplicazione di chiavi a doppia mappa, a pompa e a tagli verticali. Macchina versatile con differenti carrelli opzionali per la duplicazione di chiavi Abloy, Ford e a tagli verticali.

ALFA BIT is a semiautomatic machine for bit keys, double bits, frontal and vertical channel keys. A versatile machine with different optional carriages to allow the duplication of Abloy keys, Ford keys and vertical keys.

ALFA BIT, die halbautomatische Maschine für Guss- und Tresorschlüssel, ein- oder beidseitig, kopfseitig oder seitliche Schnitte. Eine sehr variantenreiche Maschine mit vielen optionalen Schlitten und Adaptern, die das Kopieren von Abloy-Schlüsseln, Ford-Tibbe-Schlüsseln und vertikal einzuschneidenden Schlüsseln erlaubt.

ALFA BIT est une machine économique et semi-automatique pour la duplication de clés à simple et double pannetons à pompes et à taille frontale. C'est une machine précise avec ces chariots optionnels pour la copie de clés Abloy, Ford et à taille frontale.

ALFA REGATA

ALFA REGATA è la macchina economica semi automatica per la duplicazione di chiavi a tagli verticali. Macchina versatile con differenti carrelli opzionali per la duplicazione di chiavi Doppia mappa, Abloy e Ford.

ALFA REGATA is a semiautomatic machine for vertical channel keys. A versatile machine with different optional carriages to allow the duplication of Double-Bit, Abloy keys and Ford keys.

ALFA REGATA ist eine halbautomatische Schlüsselkopierfräse für das Fräsen von Schlüsseln mit vertikalen Schnitten. Eine sehr vielseitige Maschine mit verschiedenen optionalen Spannbacken für das Kopieren von Doppelbartschlüsseln, Abloy-Schlüsseln und Ford-Tibbe-Schlüsseln.

ALFA REGATA est une machine économique et semi-automatique pour la duplication de clés à taille frontale.

C'est une machine précise avec ces chariots optionnels pour la copie de clés Abloy, Ford et à taille frontale.

ALFA FORD

ALFA FORD è la macchina speciale per la duplicazione delle chiavi Tibbe. Macchina versatile con differenti carrelli opzionali per la duplicazione di chiavi Abloy, a doppia mappa e a tagli verticali.

ALFA FORD is a machine specifically designed for the duplication of Ford Tibbe keys to code. A versatile machine with different optional carriages to allow the duplication of Abloy keys, BIT keys and vertical keys.

Die ALFA Ford ist speziell entwickelt, um die Ford-Tibbe-Schlüssel nach Code erzeugen zu können. Die veränderbare Maschine kann auch mit entsprechenden optionalen Adaptern die Schlüssel von Abloy, Guss- und Tresorschlüssel sowie vertikal einzuschneidende Schlüssel fräsen.

ALFA FORD est une machine spéciale pour la duplication des clés Tibbe.

C'est une machine précise avec ces chariots optionnels pour la copie de clés Abloy, clés à double pannetons et à taille frontale.

ALFA ABLOY

ALFA ABLOY è la macchina speciale per la duplicazione delle chiavi Abloy. Macchina versatile con differenti carrelli opzionali per la duplicazione di chiavi Ford, a doppia mappa e a tagli verticali.

ALFA ABLOY is a machine specifically designed for the duplication of Abloy keys. A versatile machine with different optional carriages to allow the duplication of Ford keys, BIT keys and vertical keys.

Die ALFA ABLOY ist speziell entwickelt, um die Abloy-Schlüssel als Kopie erzeugen zu können. Die veränderbare Maschine kann auch mit entsprechenden optionalen Adaptern die Schlüssel von Ford-Tibbe, Guss- und Tresorschlüssel sowie vertikal einzuschneidende Schlüssel fräsen.

ALFA ABLOY Est une machine spéciale pour la duplication des clés Abloy.

C'est une machine précise avec ces chariots optionnels pour la copie de clés Ford, clés à double pannetons et à taille frontale.





FRESE - FRÄSER - CUTTERS - FRAISES

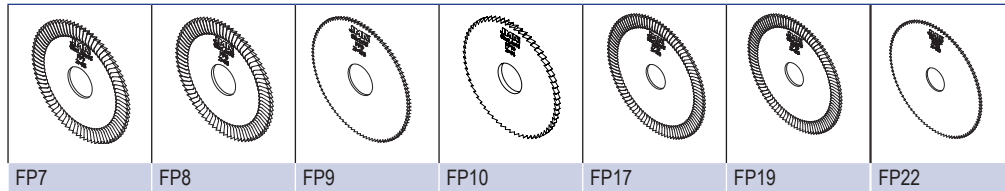

Codice	AxBxC	Tagli laterali	PER-FOR	MAT
FP7	63x1,25x16	X	ALFA BIT-ALFA ABLOY	HSS
FP7N	63x1,25x16		ALFA BIT-ALFA ABLOY	HSS
FP8	63x1,4x16	X	ALFA BIT-ALFA ABLOY	HSS-TCN
FP8N	63x1,4x16		ALFA BIT-ALFA ABLOY	HSS
FP8W	63x1,4x16		ALFA BIT-ALFA ABLOY	W
FP9	63x1x16		ALFA BIT	HSS
FP10	63x2,4x16		ALFA FORD-ALFA ABLOY	HSS
FP10W	63x2,4x16		ALFA FORD-ALFA ABLOY	W
FP17	80x1,25x16	X	DELTA PLUS-DELTA PROF.	HSS-TCN
FP19	80x1,4x16	X	DELTA PLUS-DELTA PROF.-DELTA ADV.	HSS-TCN
FP22	80x1x16		DELTA PLUS	HSS
FP22W	80x1,50x22		DELTA PROFESSIONAL	W

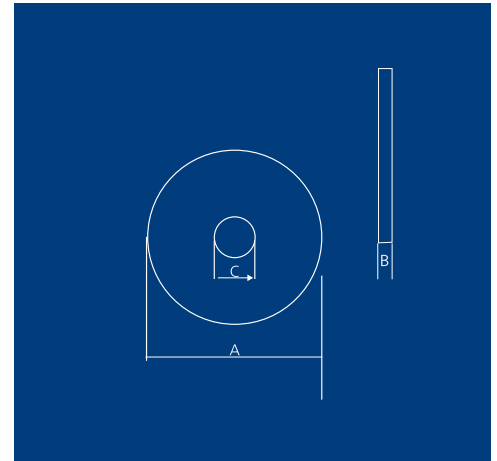

ADATTATORI - ADAPTER - ADAPTORS - ADAPTEURS

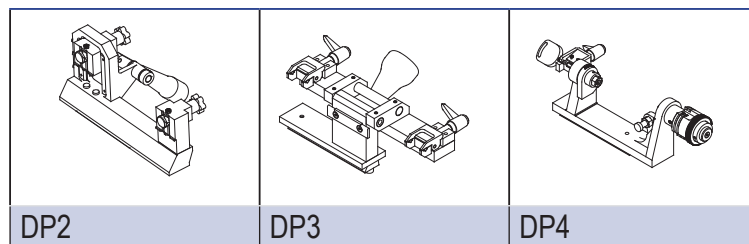
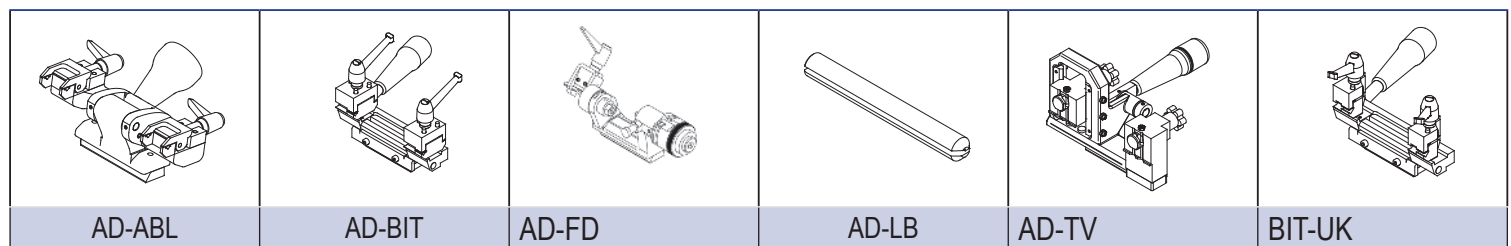

ADATTATORE	ALFA COMBI	DELTA PROF	DELTA PLUS	DELTA ADV
AD-ABL	X			
AD-BIT	X			
AD-FD	X			
AD-LB	X	X	X	X
AD-TV	X			
BIT-UK	X			
DP2		X	X	
DP3		X	X	
DP4		X	X	

GUIDA ALLA DUPLICAZIONE

DATENBLATT FÜR FACHLEUTE
SPECIALIST FILE
FICHE SPÉCIALISÉE

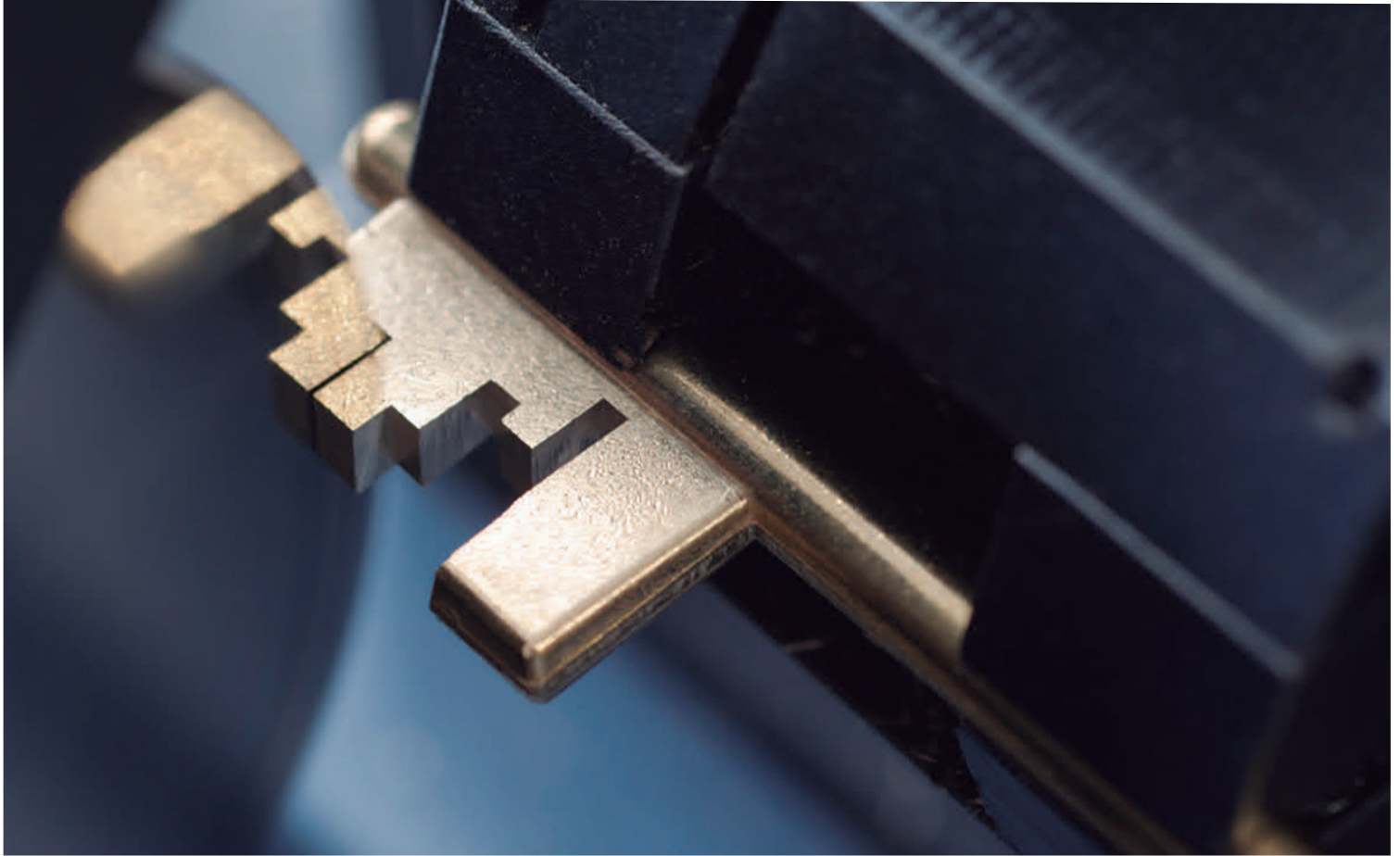







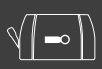

CHIAVI DOPPIA MAPPA



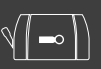

FÜR BARTSCHLÜSSEL
FOR BIT KEYS
POUR CLES À GORGES

DELTA PROFESSIONAL - DELTA ADVANCE - ALFA BIT -
ALFA REGATA - ALFA FORD - ALFA ABLOY

CERREBI[®]

FOR:						
ABLOY®	AB1	DELTA PROF		DP3		
		DELTA PLUS		DP3		
		ALFA COMBI		AD-ABL		
	AB1P52	DELTA PROF		DP3		
		DELTA PLUS		DP3		
		ALFA COMBI		AD-ABL		
	AB2	DELTA PROF		DP3		
		DELTA PLUS		DP3		
		ALFA COMBI		AD-ABL		
	AB3	DELTA PROF		DP3		
		DELTA PLUS		DP3		
		ALFA COMBI		AD-ABL		
	AB4	DELTA PROF		DP3		
		DELTA PLUS		DP3		
		ALFA COMBI		AD-ABL		
	AB5	DELTA PROF		DP3		
		DELTA PLUS		DP3		
		ALFA COMBI		AD-ABL		
	AB6	DELTA PROF		DP3		
		DELTA PLUS		DP3		
		ALFA COMBI		AD-ABL		
	ABUS®	AU25	DELTA PROF		DP3	
			DELTA PLUS		DP3	
		AU54P117	DELTA PROF		DP3	
DELTA PLUS				DP3		
ANCHOR®	ACR2	DELTA PROF		DP3		
		DELTA PLUS		DP3		
		ALFA COMBI		AD-ABL		
DIEBOLD®	DIE1	DELTA PROF		AD-LB		
		DELTA PLUS		AD-LB		
		ALFA COMBI		AD-BIT		
				AD-LB		
		DELTA ADV		AD-LB		
IFAM®	IF10P149	ALFA COMBI		AD-BIT		
				AD-LB		
		DELTA PROF		AD-LB		
		DELTA PLUS		AD-LB		
		DELTA ADV		AD-LB		
	ORIGINAL IF1922	ALFA COMBI		AD-BIT		
				AD-LB		

FOR:					
IFAM®	ORIGINAL IF1922	DELTA PROF		AD-LB	
		DELTA PLUS		AD-LB	
		DELTA ADV		AD-LB	
				AD-LB	
MILES®	MIL1	DELTA PROF		AD-LB	
		DELTA PLUS		AD-LB	
		ALFA COMBI		AD-LB	
		DELTA ADV		AD-LB	
	MIL2	DELTA PROF		AD-LB	
		DELTA PLUS		AD-LB	
		ALFA COMBI		AD-LB	
DELTA ADV			AD-LB		
PENZMASH®	PNZ2	ALFA COMBI		AD-BIT	
				AD-LB	
		DELTA PROF		AD-LB	
		DELTA PLUS		AD-LB	
		DELTA ADV		AD-LB	
RIL®	RL1	ALFA COMBI		AD-BIT	
				AD-LB	
		DELTA PROF		AD-LB	
		DELTA PLUS		AD-LB	
		DELTA ADV		AD-LB	
SERRETA®	SRT1	ALFA COMBI		AD-BIT	
				AD-LB	
		DELTA PROF		AD-LB	
		DELTA PLUS		AD-LB	
TIBBE®	TB1P5	ALFA COMBI		AD-FD	
		DELTA PROF		DP4	
		DELTA PLUS		DP4	
	T00TB1P	ALFA COMBI		AD-FD	
		DELTA PROF		DP4	
		DELTA PLUS		DP4	
	TB2P96	ALFA COMBI		AD-FD	
		DELTA PROF		DP4	
		DELTA PLUS		DP4	
					AD-FD
T00TB2P	ALFA COMBI		AD-FD		
	DELTA PROF		DP4		
	DELTA PLUS		DP4		
				AD-FD	
T00TB4P	ALFA COMBI		AD-FD		
	DELTA PROF		DP4		
	DELTA PLUS		DP4		
				AD-FD	

FOR:			
			
			
TRUPER®	TRP1P	ALFA COMBI	AD-BIT
			AD-LB
		DELTA PROF	AD-LB
		DELTA PLUS	AD-LB
		DELTAADV	AD-LB
URKO®	URK1	ALFA COMBI	AD-BIT
			AD-LB
		DELTA PROF	AD-LB
		DELTA PLUS	AD-LB
		DELTAADV	AD-LB
YALE-CISA®	CY	ALFA COMBI	AD-BIT
			AD-LB
		DELTA PROF	AD-LB
		DELTA PLUS	AD-LB
		DELTAADV	AD-LB
YMOS®	YM25P5	ALFA COMBI	BIT-UK
			DP3
			DP3

CHIAVI
SCHLÜSSEL
KEYS
CLES



ERREBI[®]

PER / FOR

ABLOY® (SE)

ABUS® (DE)

FOR: ABLOY®

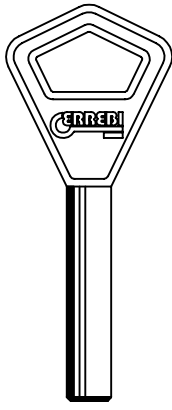

AB1

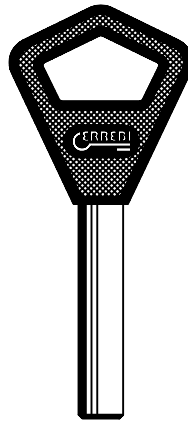

AB1P52

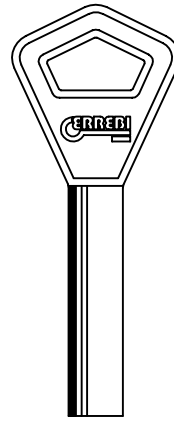

AB2

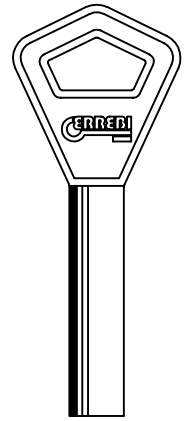

AB3

FOR: ABLOY®

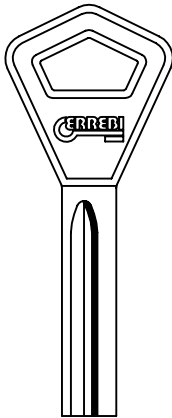

AB4

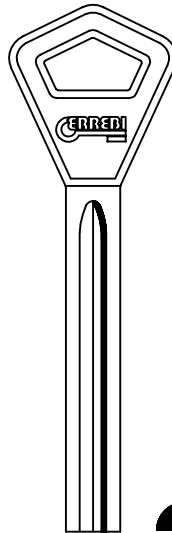

AB5

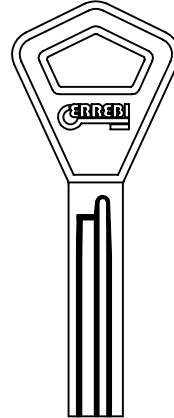

AB6

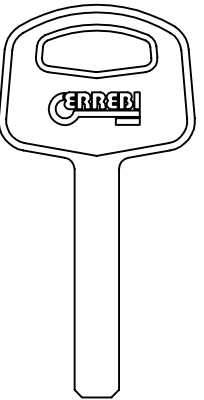

AU25

FOR: ABUS®

FOR: ABUS®

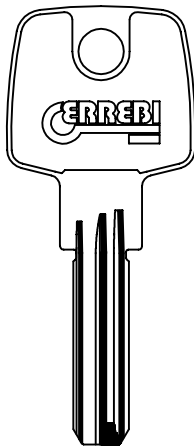

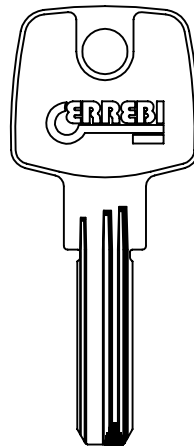

AU50

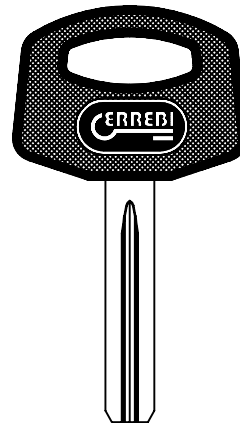

AU55

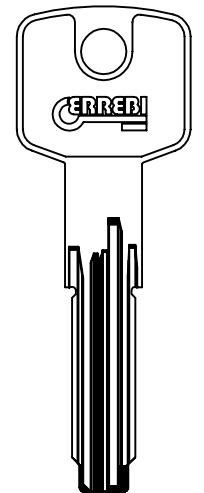

AU54P117



AU57L

ERREBI

Copyright by
Errebi s.p.a. Unipersonale 2018

UNI EN ISO 9001:2008



SISTEMA DI GESTIONE
QUALITÀ CERTIFICATO

CERTIQUALITY
È MEMBRO DELLA
FEDERAZIONE CISO

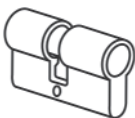

FOR: ABUS®

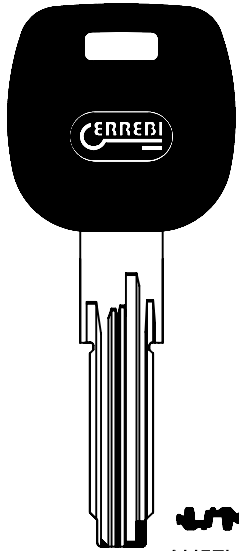

AU57LP

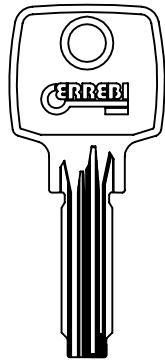

AU72

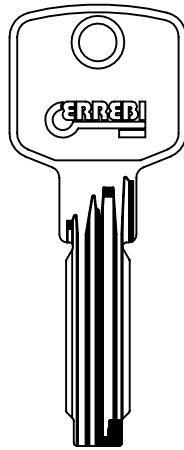

AU82

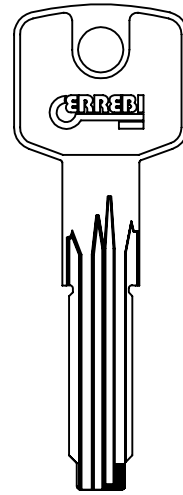

AU91L

FOR: ABUS®

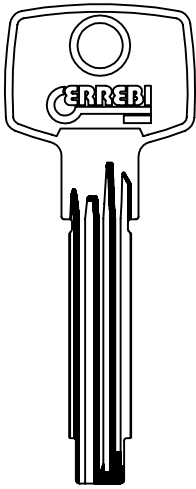

AU103

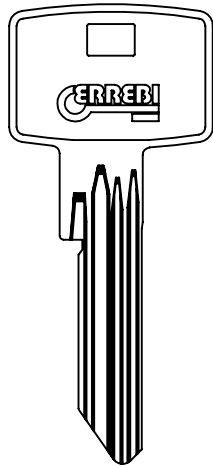

AU105R

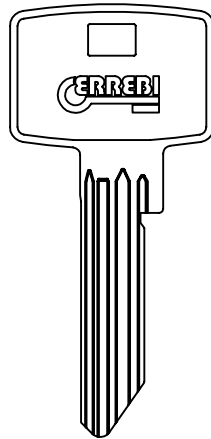

AU106

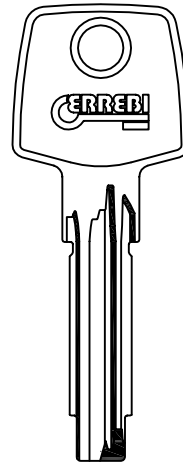

AU109

FOR: AGA®

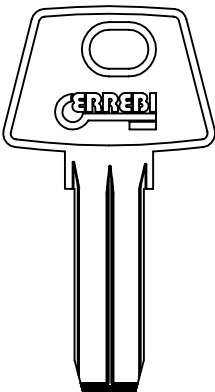

AGA12

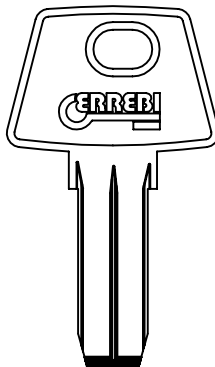

AGA13

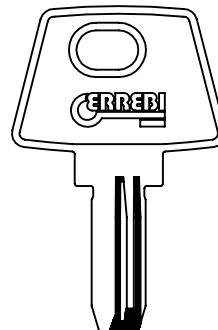

AGA23 AGA29

PER / FOR

ABUS® (DE)

AGA® (ES)



Copyright by
Errebi s.p.a. Unipersonale 2018

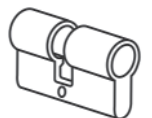

PER / FOR

AGA® (ES)

AGB® (IT)

FOR: AGA®

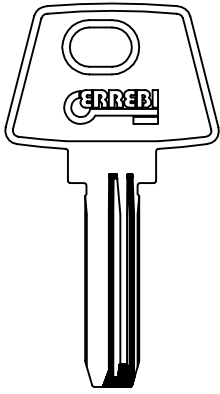

AGA14

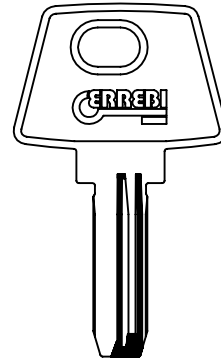

AGA15



AGA21



AGA22



AGA27



AGA28

FOR: AGA®

FOR: AGB®

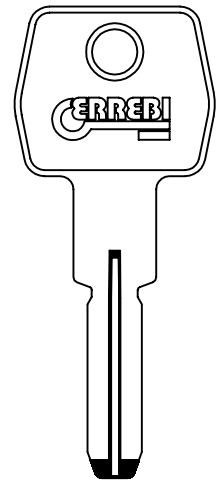
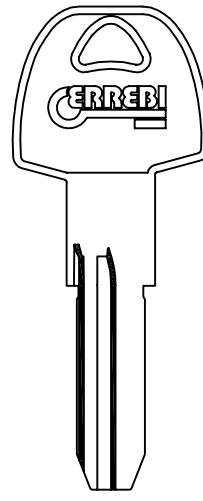
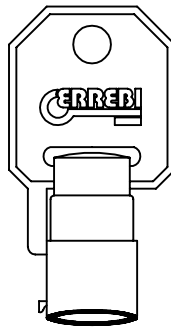
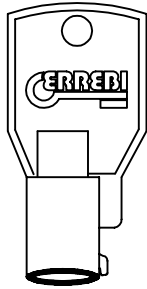

AGA19T



AGA20T



AGA30



AGB6

FOR: AGB®

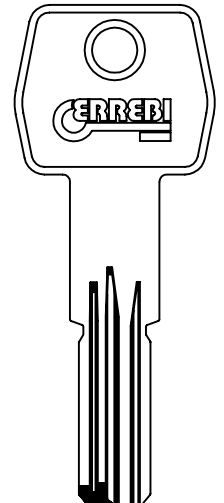
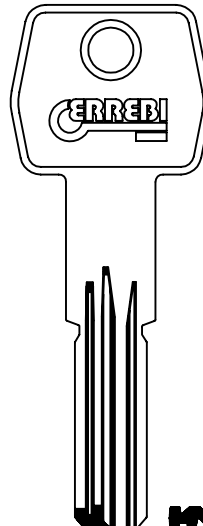
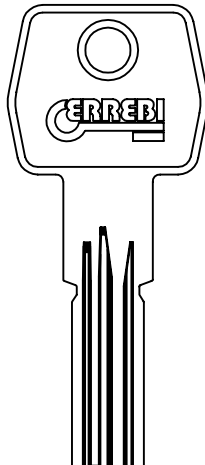
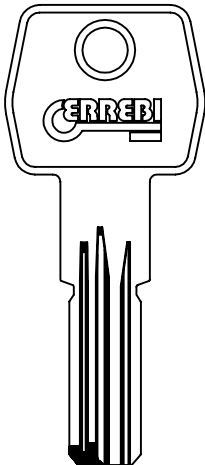

AGB7



AGB8



AGB9



AGB10

ERREBI®

Copyright by
Errebi s.p.a. Unipersonale 2018









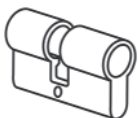

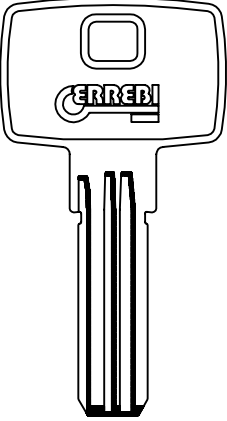

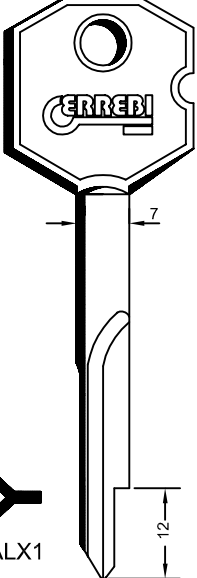

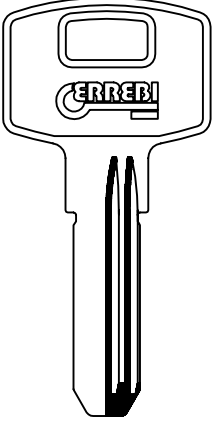

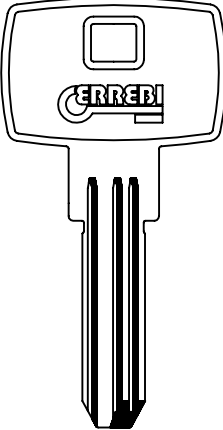

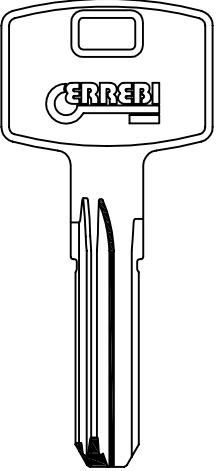

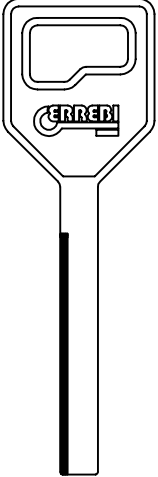

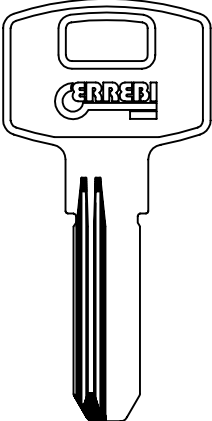

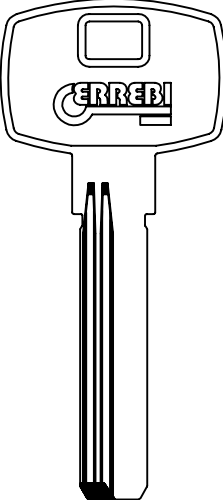
UNI EN ISO 9001:2008

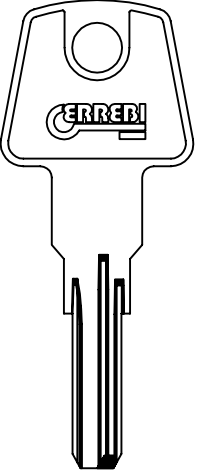

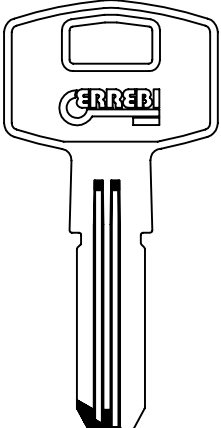
SISTEMA DI GESTIONE
QUALITÀ CERTIFICATO

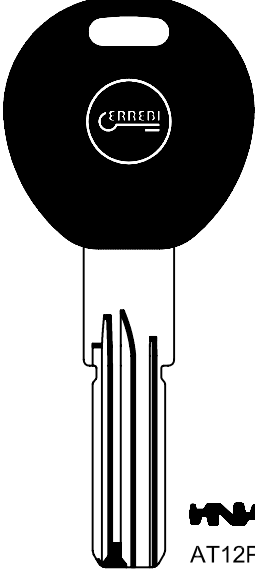
CERTIQUALITY
È MEMBRO DELLA
FEDERAZIONE CISO

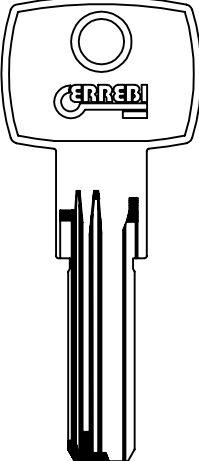

FOR: AHRAM®	FOR: ALA®	FOR: AMIG®	
   AHR2 AHR3	  ALX1	   AMG1 AMG1R	  AMG2
FOR: AMIG®	FOR: ANCHOR®	FOR: APEX®	
  AMG3	  ACR2	   APE2 APE3	  APE4
FOR: APEX®	FOR: ASHICO®	FOR: ATRA®	FOR: AUNO®
  APE5	  ASH1	  AT12P	  AUN1R

PER / FOR

AHRAM® (EG)
ALA® (IT)
AMIG® (ES)
ANCHOR® (SE)
APEX® (RU)
ASHICO® (CN)
ATRA® (IT)
AUNO® (IT)



Copyright by
Errebi s.p.a. Unipersonale 2018

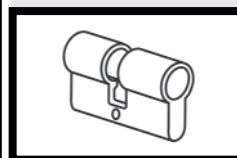

PER / FOR

AXA® (NL)
 AZBE® (ES)
 BAGEM® (ES)

FOR: AXA®

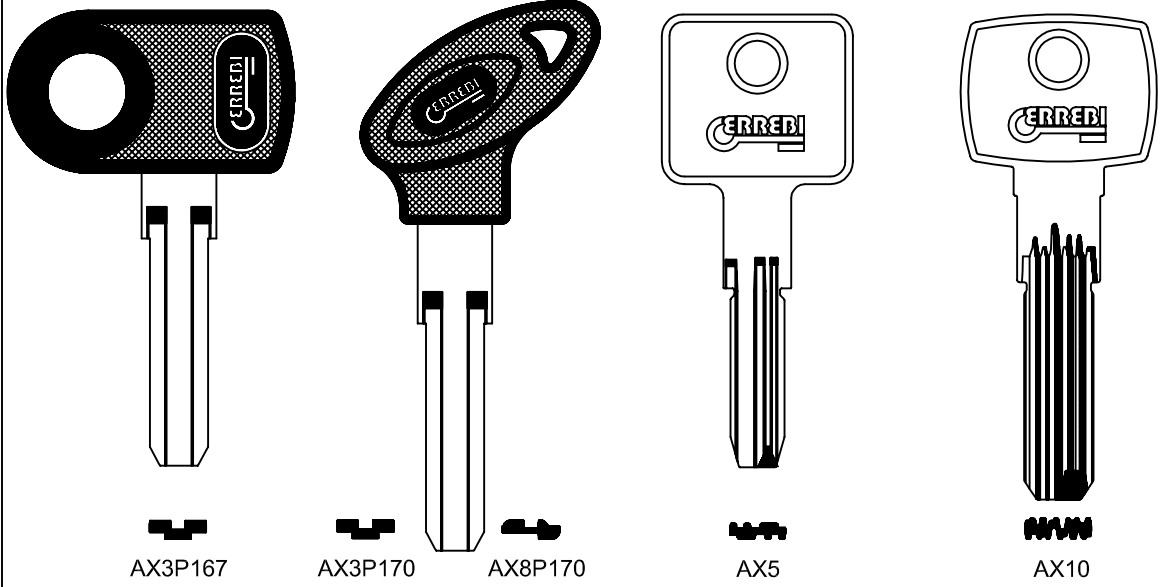

FOR: AZBE®

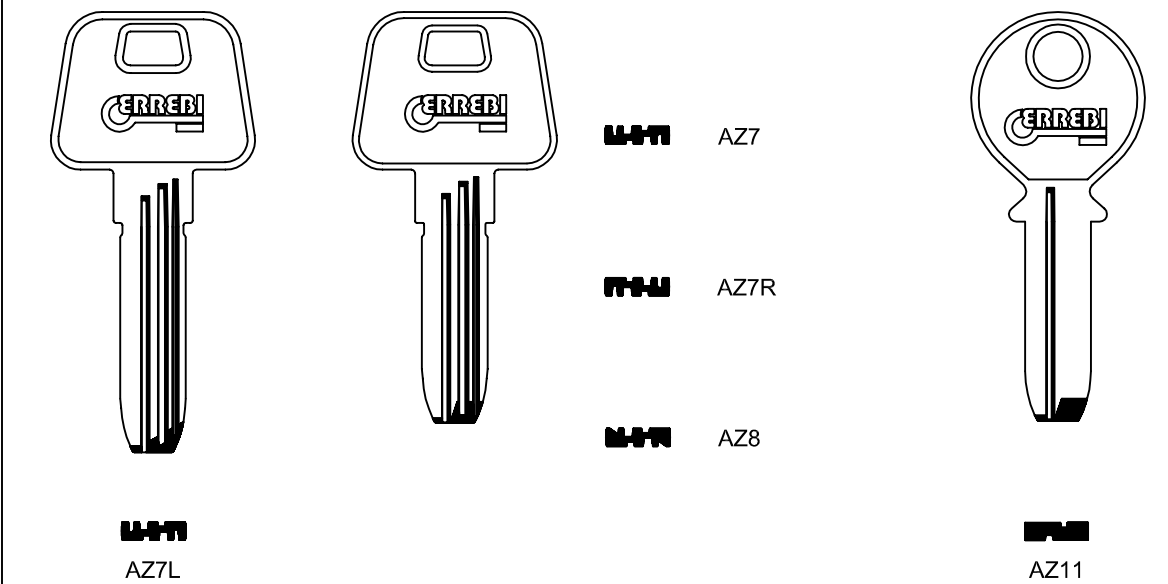

FOR: AZBE®

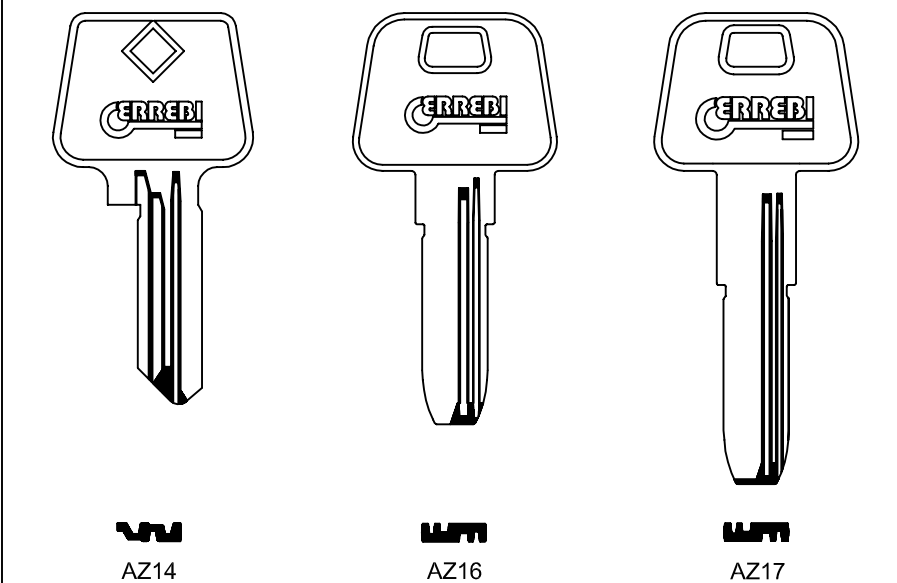

FOR: BAGEM®

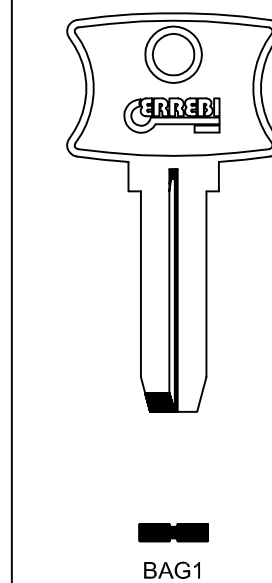

Copyright by
 Errebi s.p.a. Unipersonale 2018

UNI EN ISO 9001:2008









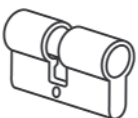

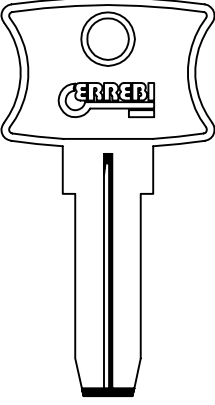
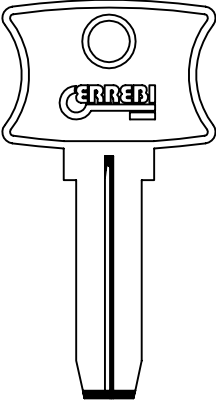
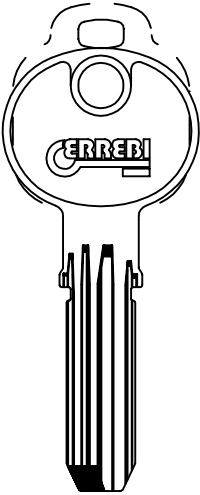
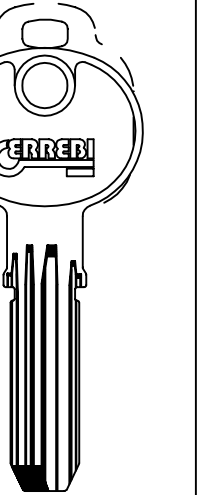
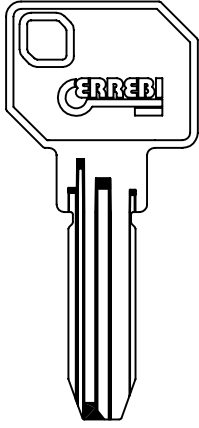





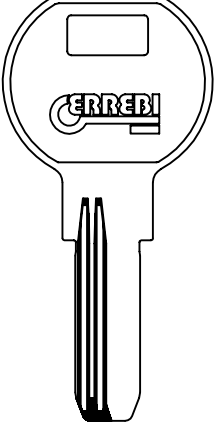
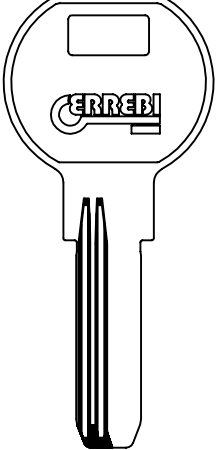
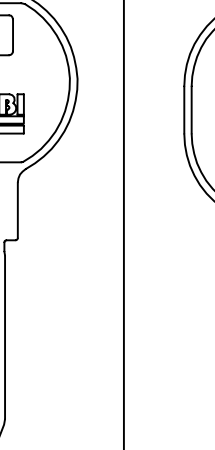
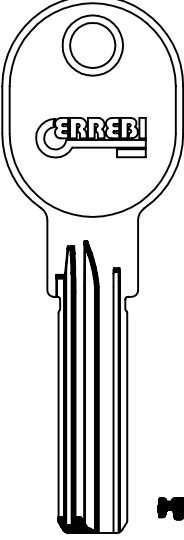
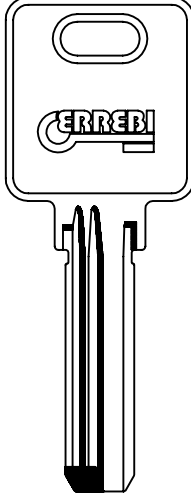



CERTIQUALITY
 È MEMBRO DELLA
 FEDERAZIONE CISO

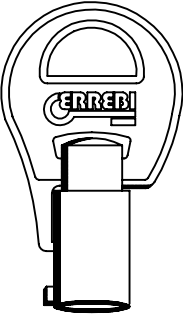
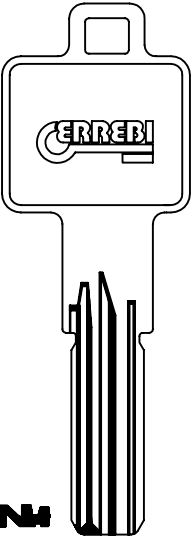
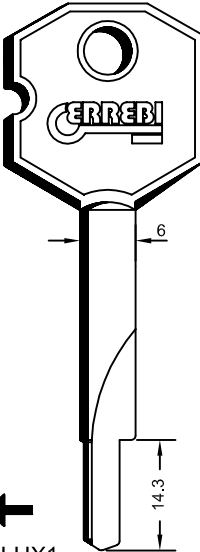
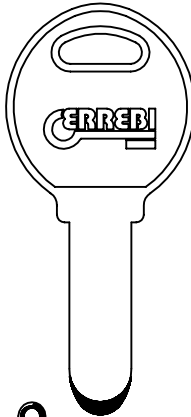

SISTEMA DI GESTIONE
 QUALITÀ CERTIFICATO



FOR: BAGEM®		FOR: BALING LOCK®		FOR: BANE S.S.®	
					
					
BAG2	BAG3	BAK1	BAK2	BN11	
FOR: BASI®			FOR: BEY®		
					
					
BSI2R	BSI3R	BSI3	BEY1	BEY2	
FOR: BILMA®	FOR: BKS®	FOR: BLUMA®	FOR: BÖRKEY®		
					
					
BIL1T	KS50	BLUX1	BOR1		

- PER / FOR**
- BAGEM® (ES)
 - BALING LOCK® (CN)
 - BANE® (CS)
 - BASI® (DE)
 - BEY® (TR)
 - BILMA® (ES)
 - BKS® (DE)
 - BLUMA® (DE)
 - BÖRKEY® (DE)



Copyright by
Errebi s.p.a. Unipersonale 2018

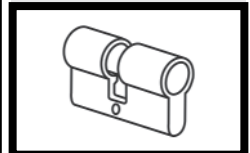

PER / FOR

BÖRKEY® (DE)
 BRAS® (ES)
 BRICARD® (FR)

FOR: BÖRKEY®

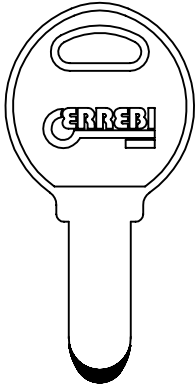

 BOR2

FOR: BRAS®

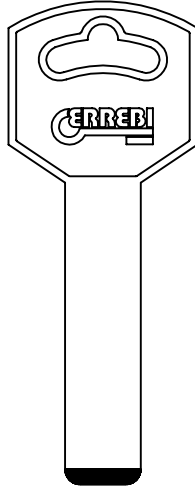

 BRA1

FOR: BRICARD®

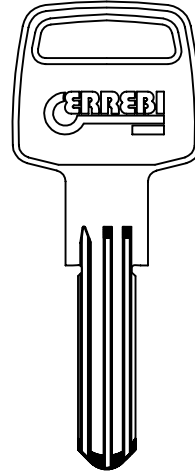

 BD12R

 BD22

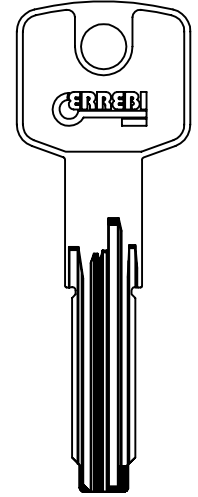

 BD23L

 BD27

FOR: BRICARD®

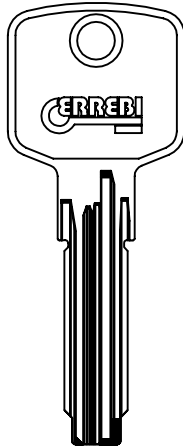

 BD25

 BD26

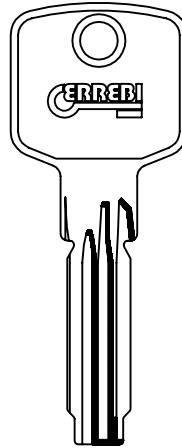

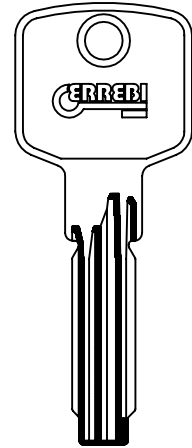

 BD28



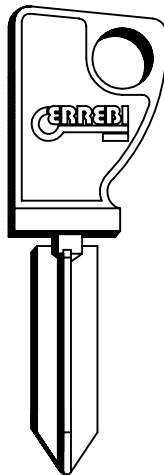

 BD29

FOR: BRICARD®





 BD710

 BD720

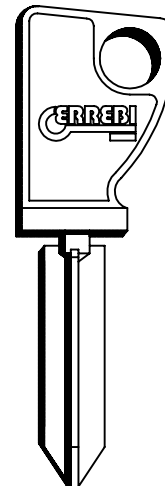
 BD730



 BD740

 BD750

 BD760



Copyright by
 Errebi s.p.a. Unipersonale 2018









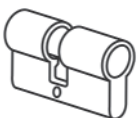

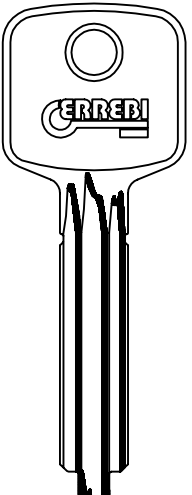

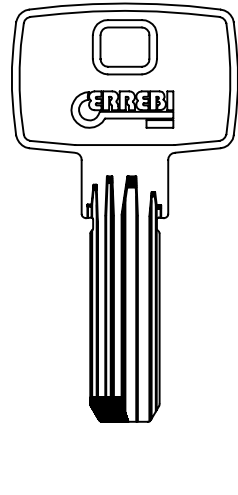

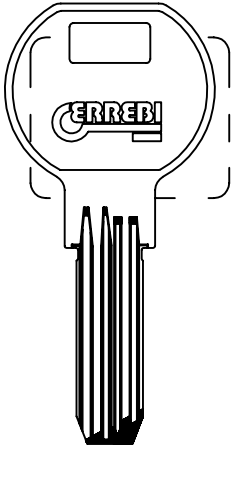

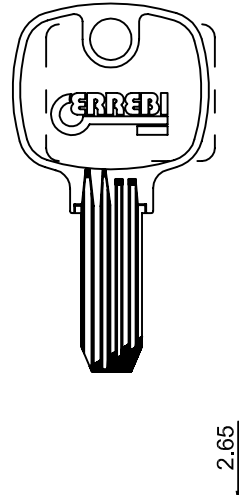

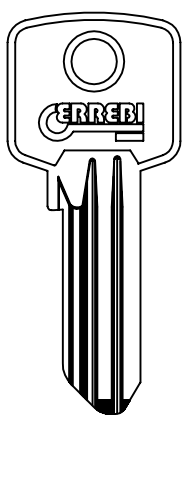
UNI EN ISO 9001:2008

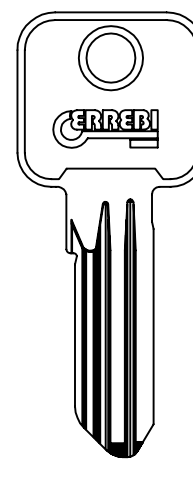
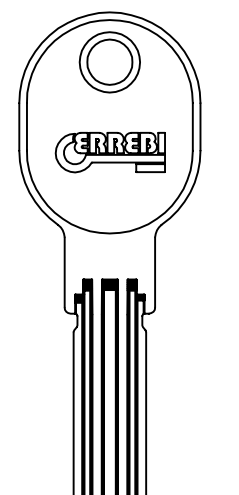

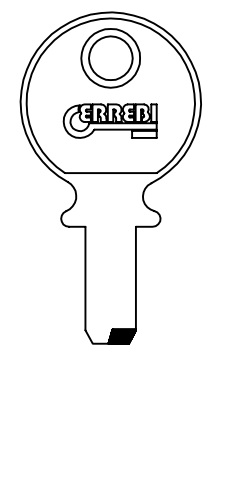
SISTEMA DI GESTIONE
 QUALITÀ CERTIFICATO

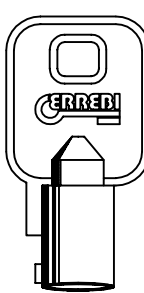
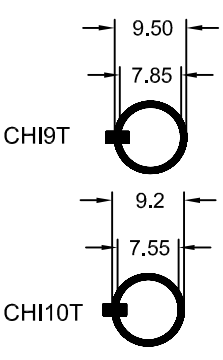
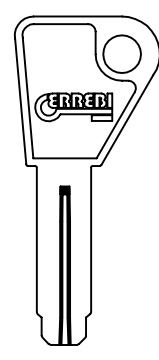
CERTIQUALITY
 È MEMBRO DELLA
 FEDERAZIONE CISO

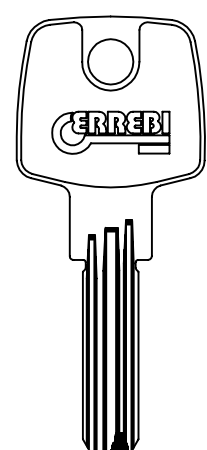

FOR: BRISANT®	FOR: BULAT®	FOR: BURG®	
  BRS1 BRS2	  BUL1	  BG43	  BG44 BG56
FOR: CAS-CISMA®		FOR: CAYS®	FOR: CES®
  CIS6 CIS8 CIS9		  CAY2	  CE42
FOR: CHICAGO®	FOR: CHUBB®	FOR: CISA®	
  CHI9T	  CB7	  C21	

PER / FOR

- BRISANT® (GB)
- BULAT® (TW)
- BURG® (DE)
- CAS-CISMA® (IT)
- CAYS® (ES)
- CES® (DE)
- CHICAGO® (US)
- CHUBB® (GB)
- CISA® (IT)



Copyright by
Errebi s.p.a. Unipersonale 2018

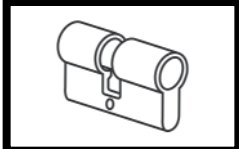

PER / FOR

CISA® (IT)
 CORBIN® (IT)
 C.R.® (IT)
 CVL® (ES)

FOR: CISA®

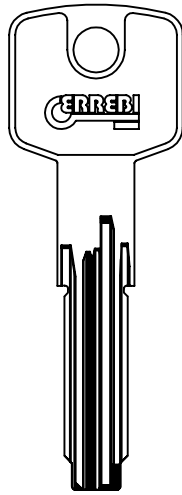

- | | | |
|------|--|-------|
| C24L | | C24LP |
| C25L | | C25LP |
| C28L | | C28LP |
| | | C33LP |
| C34L | | C34LP |
| C40L | | C40LP |
| | | C46LP |
| | | C47LP |
| | | C51LP |
| | | C52LP |
| | | C57LP |
| | | C62LP |

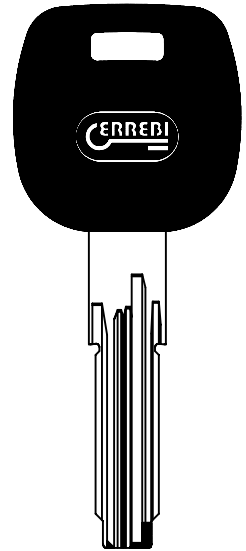

FOR: CISA®

FOR: CORBIN®

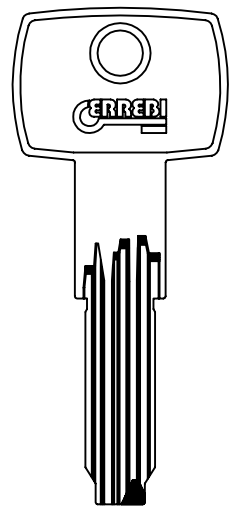
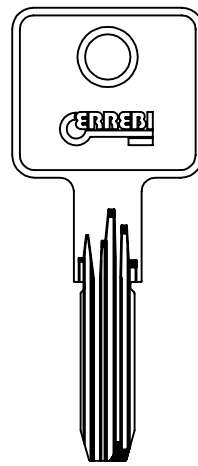
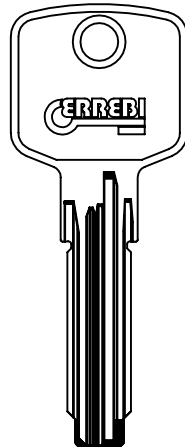
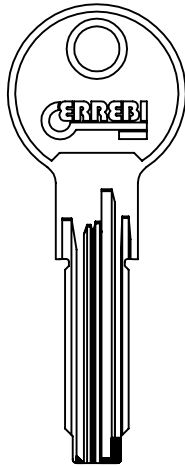

C25T

C27T

C53

C61

CO55

CO58

FOR: C.R.®

FOR: CVL®

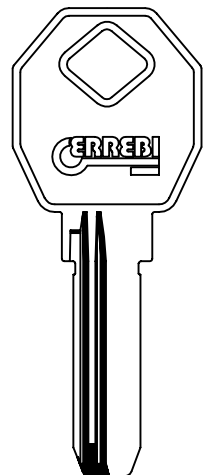
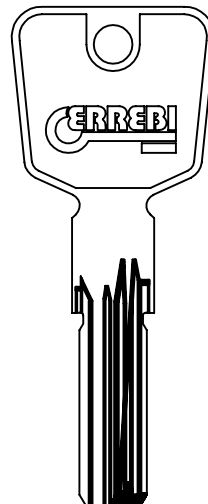
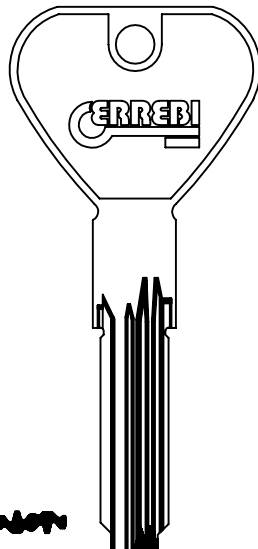
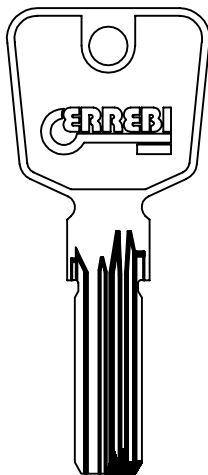

TT13

TT20

TT27

CV9



Copyright by
 Errebi s.p.a. Unipersonale 2018

UNI EN ISO 9001:2008





CERTIQUALITY
 È MEMBRO DELLA
 FEDERAZIONE CISO

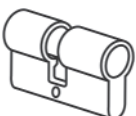

SISTEMA DI GESTIONE
 QUALITÀ CERTIFICATO

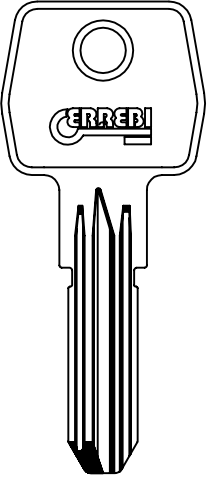

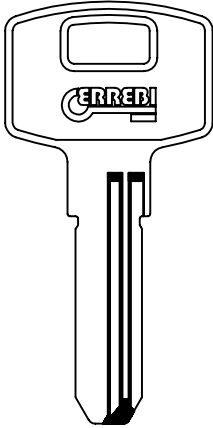
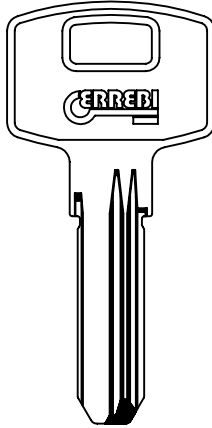
FOR: DAF ®	FOR: DEKABA ®
  	 

PER / FOR

DAF® (GB)
 DEKABA® (BG)
 DELCA® (GR)

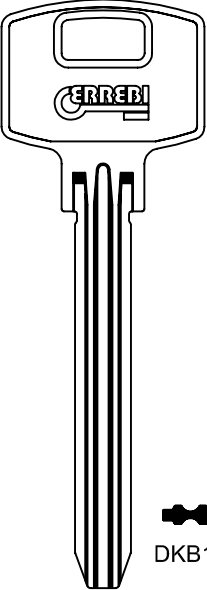
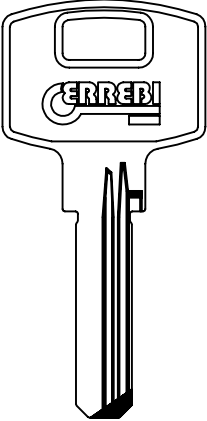
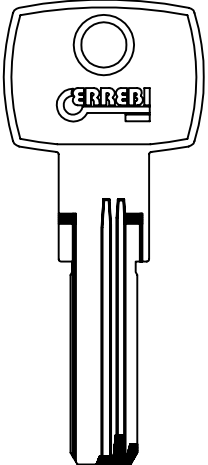
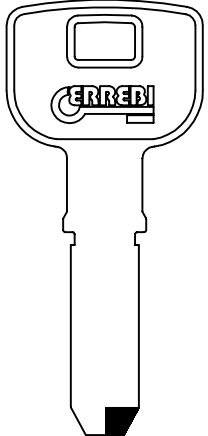
FOR: DEKABA ®		FOR: DELCA ®	
 			

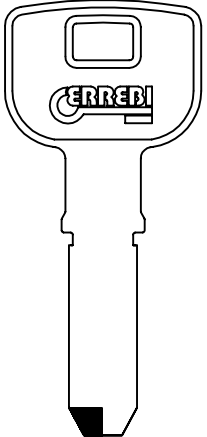
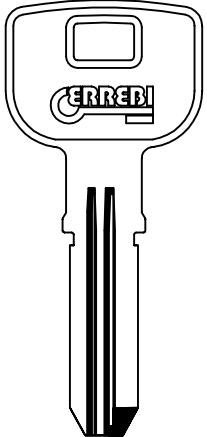
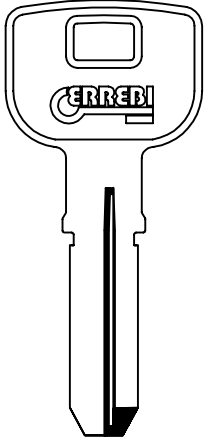
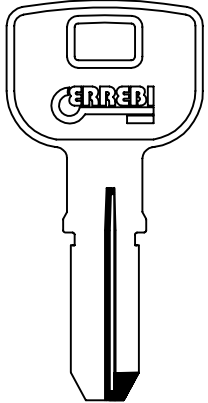
FOR: DELCA ®			
			



Copyright by
 Errebi s.p.a. Unipersonale 2018

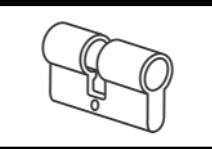

PER / FOR

DELTA® (GB)
 DIAMOND® (TW)
 DIEBOLD® (DE)
 DIERRE® (IT)
 DOM® (DE)

FOR: DELTA®

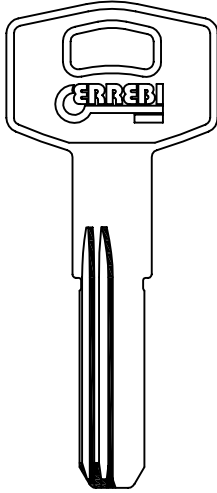

DLT1R

FOR: DIAMOND®

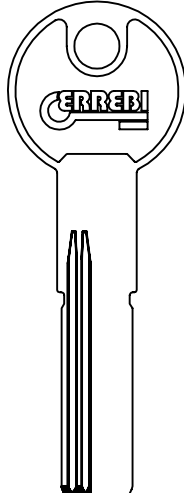

DI2



DI3

FOR: DIEBOLD®

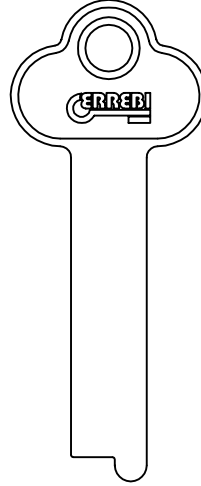

DIE1

FOR: DIERRE®

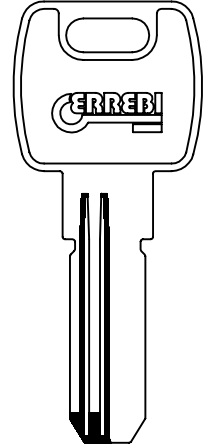

DR2

FOR: DOM®

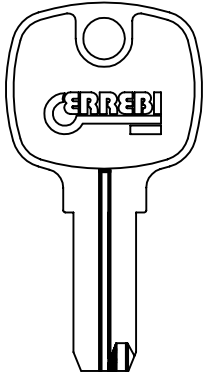

DM27

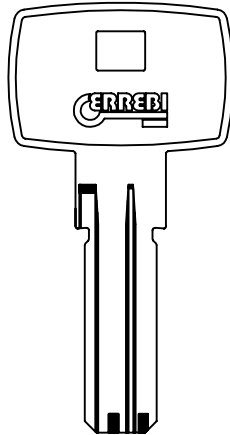

DM39L



DM60L

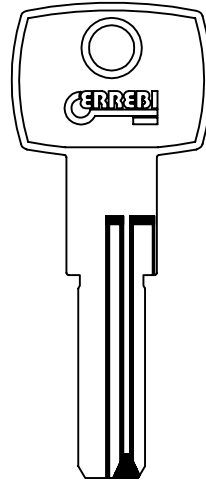

DM37L



DM38L



DM75L



DM82L

FOR: DOM®

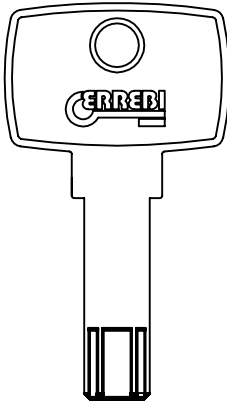

DM46

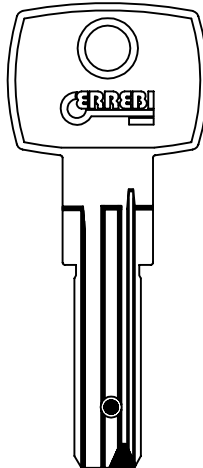

DM75LB

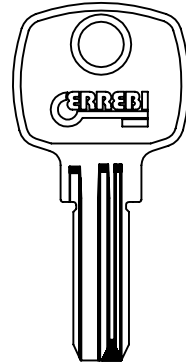

DM76



DM83L

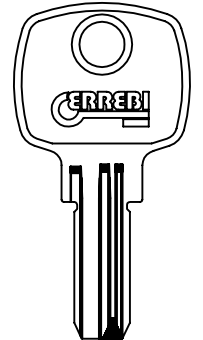

DM77



DM83



Copyright by
 Errebi s.p.a. Unipersonale 2018

UNI EN ISO 9001:2008



SISTEMA DI GESTIONE
 QUALITÀ CERTIFICATO

CERTIQUALITY
 È MEMBRO DELLA
 FEDERAZIONE CISO

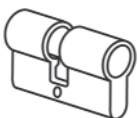

FOR: DOM®

FOR: DOMUS®

PER / FOR

DOM® (DE)
DOMUS® (GR)
ELZETT® (HU)
EURO LOCKS® (BE)
EVVA® (AT)

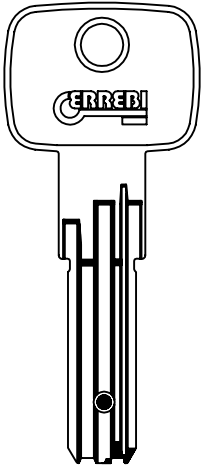

DM102

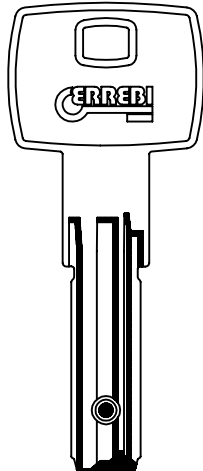

DM106

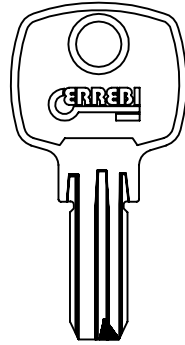

DM107

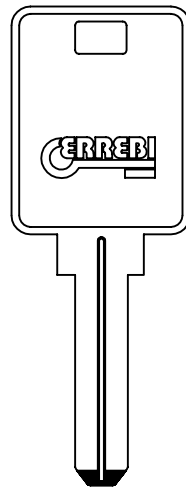

DO6



DO7

FOR: ELZETT®

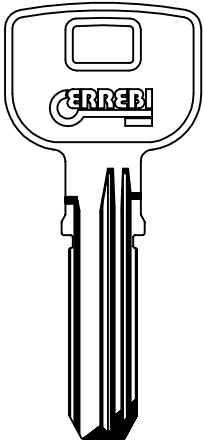

EZ12



EZ12R

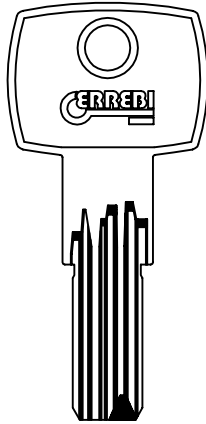

EZ14

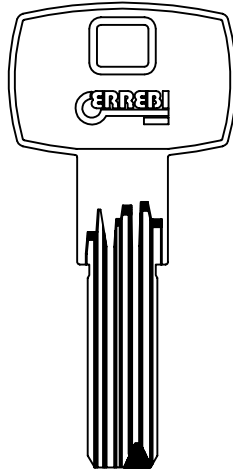

EZ15

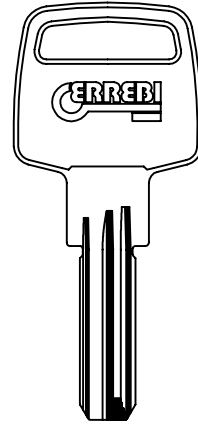

EZ18

FOR: EURO LOCKS®

FOR: EVVA®

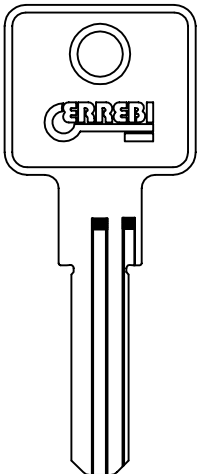

EL11

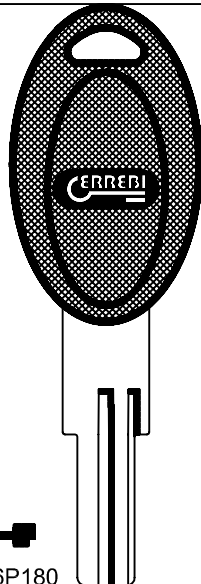

EL16P180

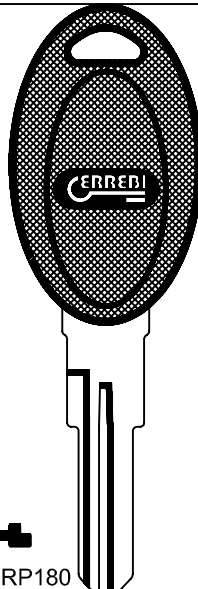

EL17RP180

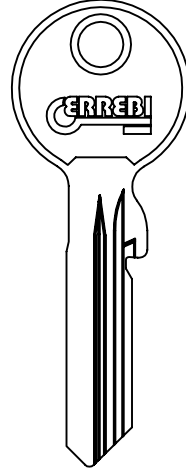

EV24



Copyright by
Errebi s.p.a. Unipersonale 2018

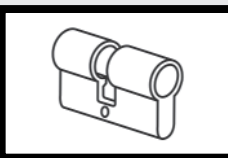

PER / FOR

- EZCURRA® (ES)
- FAC® (ES)
- FACCHINETTI® (IT)
- FAVOUR® (DZ)
- FAYN® (TR)
- FIAM® (IT)

FOR: EZCURRA®

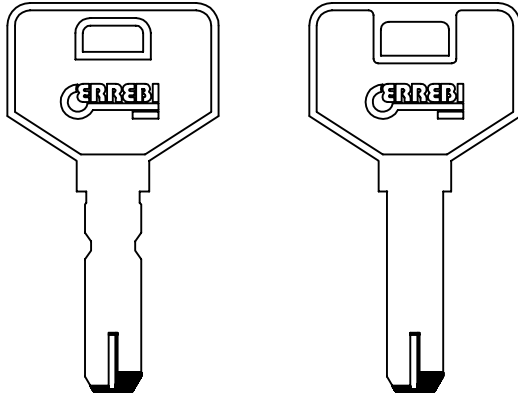

ECU6 ECU7 ECU8 ECU9

FOR: FAC®



FAC19 FAC23

FOR: FAC®

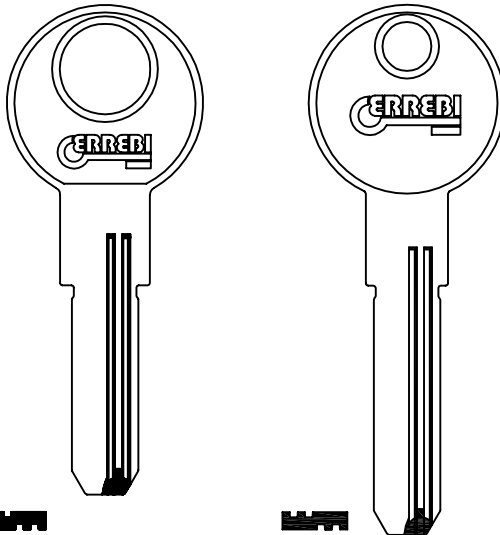

FAC24 FAC25

FOR: FACCHINETTI®

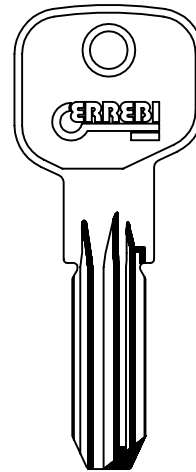

FF21

FOR: FAVOUR®

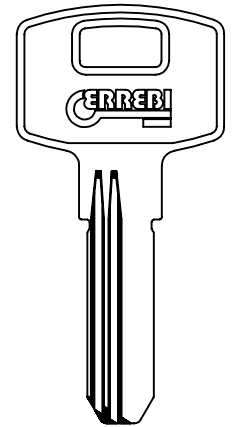

FAV1R FAV2

FOR: FAYN®

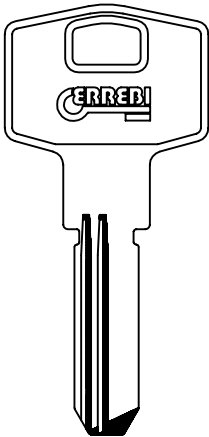

FAY2R

FOR: FIAM®

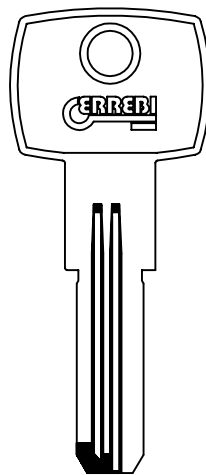

FM3R

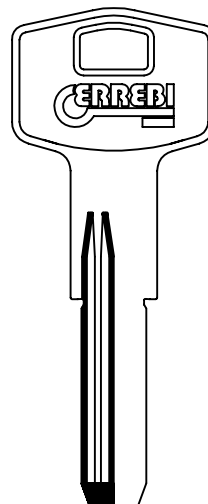

FM4

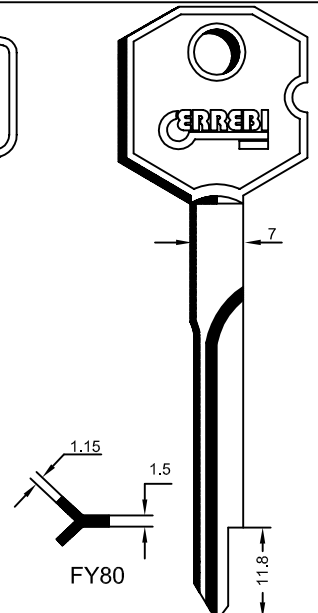

FY80



Copyright by
Errebi s.p.a. Unipersonale 2018

UNI EN ISO 9001:2008



CERTIQUALITY
È MEMBRO DELLA
FEDERAZIONE CISO



SISTEMA DI GESTIONE
QUALITÀ CERTIFICATO

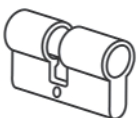

FOR: FIAM-YALE®

FOR: FICHET®

PER / FOR

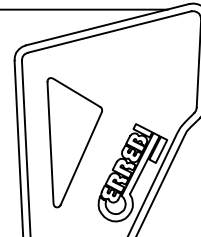
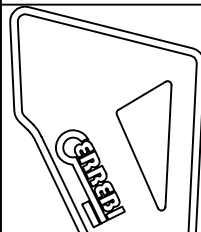
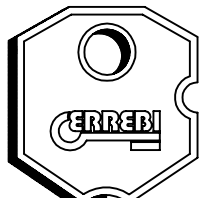
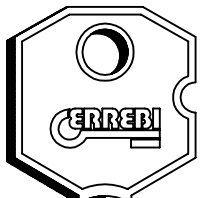

FIAM -YALE® (IT)
FICHET® (FR)
PROGRES-FONT.® (FR)
FTH® (FR)

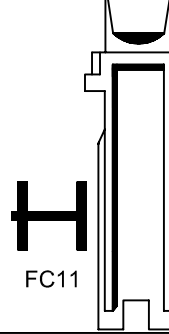
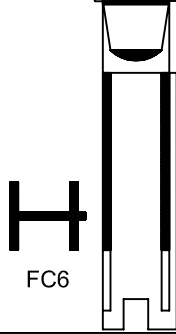
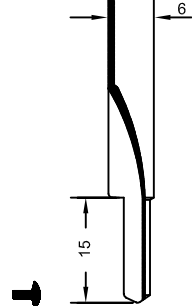
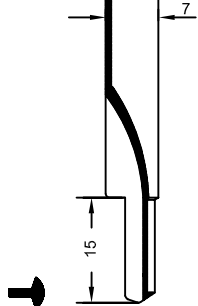

FXT1

FXT2

FC6

FC11

FOR: FICHET®

FOR: PROGRES-FONTAINE®

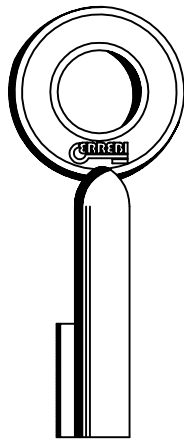
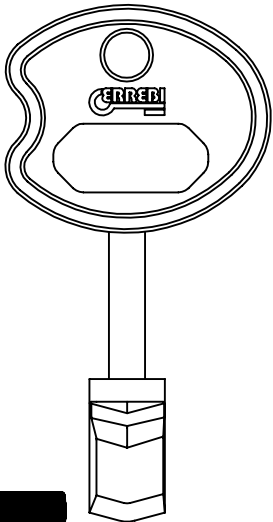

PF1



PF1F6

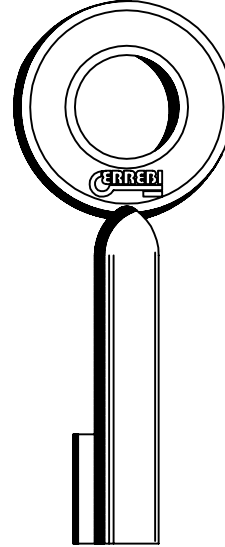

PF1F4L

FC14

FOR: FTH®

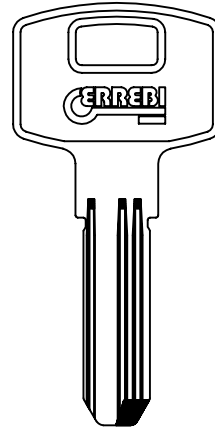
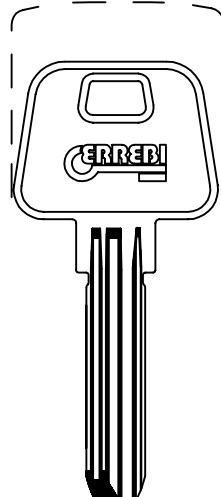
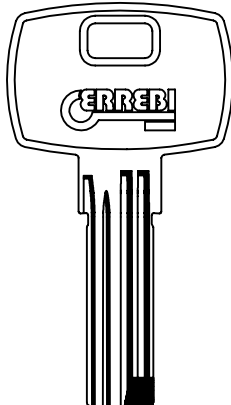
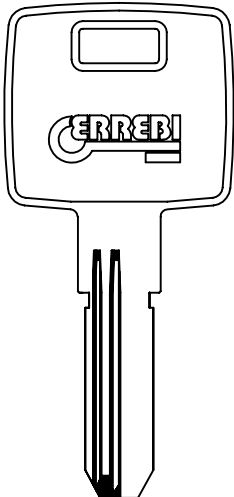

FT10



FT20



FT22



FT25



FT29





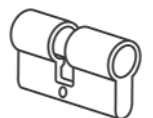





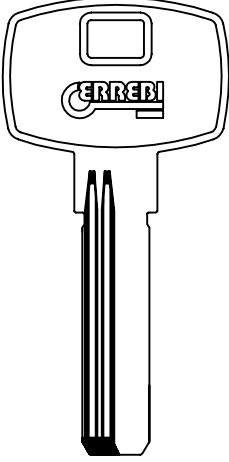
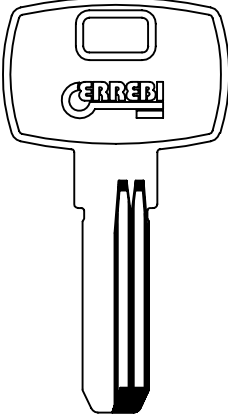
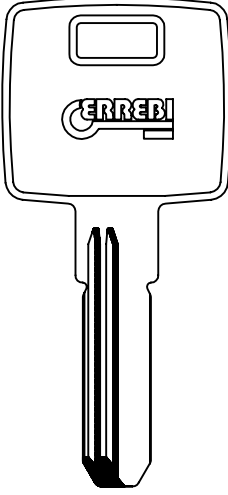
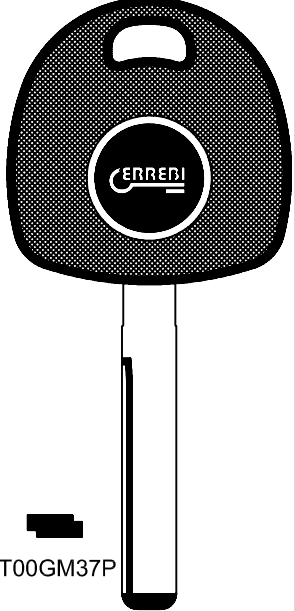



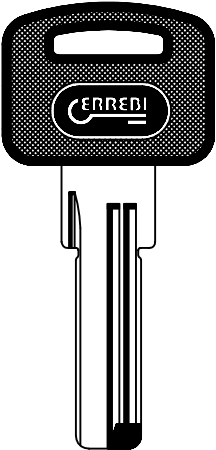
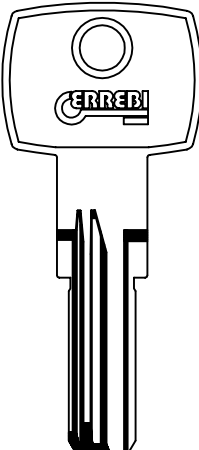
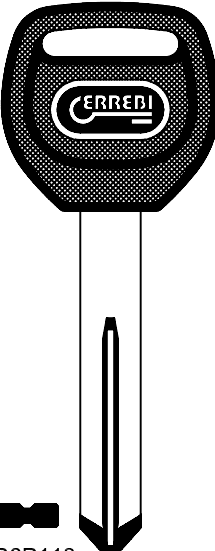
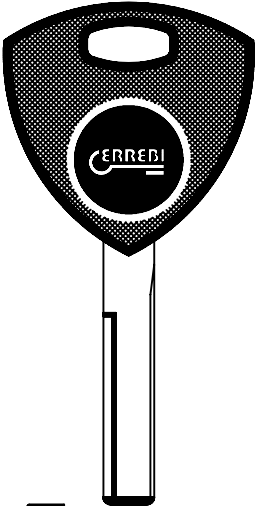

Copyright by
Errebi s.p.a. Unipersonale 2018

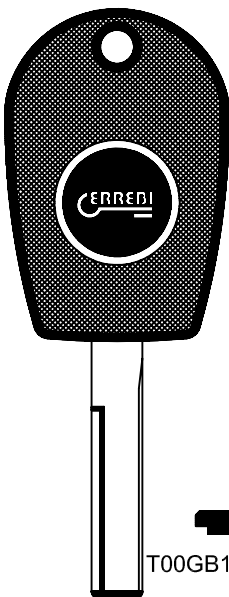

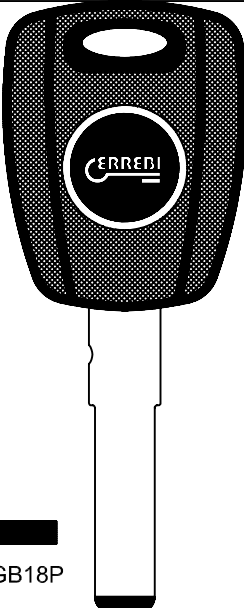
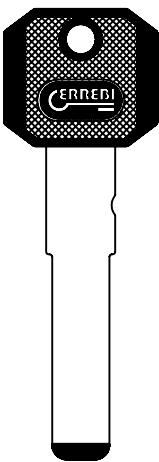
PER / FOR

- FTH® (FR)
- FUARO® (TW)
- G.M.® (US)
- GERDA® (PL)
- GEVY® (GR)
- GIOBERT-TRW-SIPEA® (IT)

FOR: FTH®		FOR: FUARO®		FOR: G.M.®	
					
					
FT26R	FT27	FUA1R	T00GM37P		
FOR: GERDA®		FOR: GEVY®		FOR: GIOBERT-TRW-SIPEA®	
					
					
GDA1P164	GEV1	GB6P113	T00GB17RPA		
FOR: GIOBERT-TRW-SIPEA®					
					
					
T00GB17RPB	GB18C1	GB18P	GB18P174		



Copyright by
Errebi s.p.a. Unipersonale 2018

UNI EN ISO 9001:2008









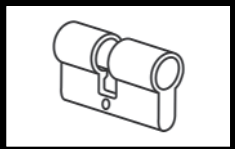

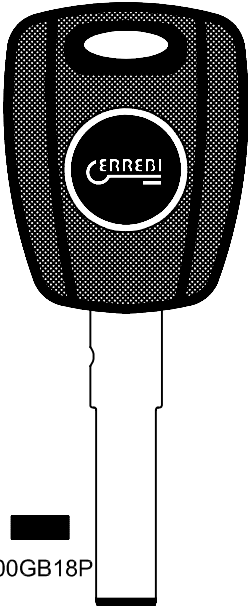
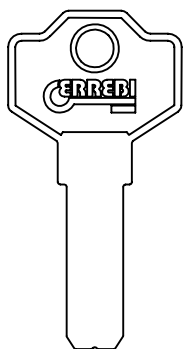
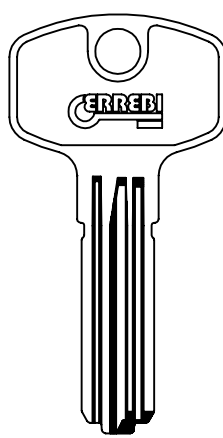
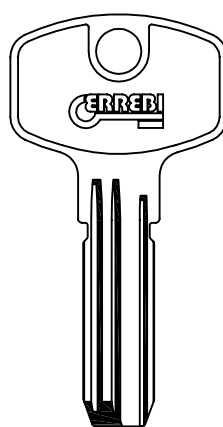
CERTIQUALITY
È MEMBRO DELLA
FEDERAZIONE CISO





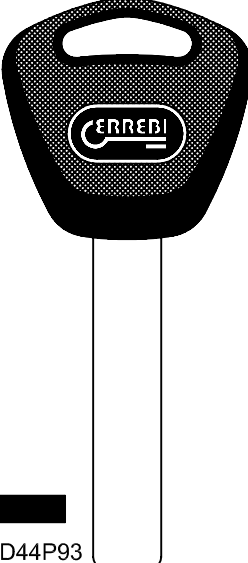
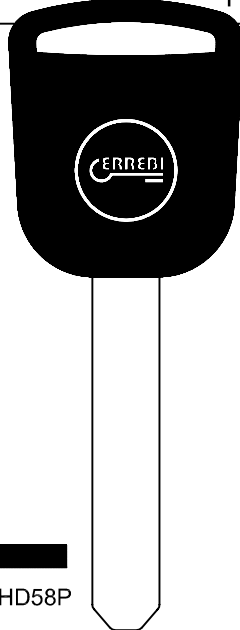
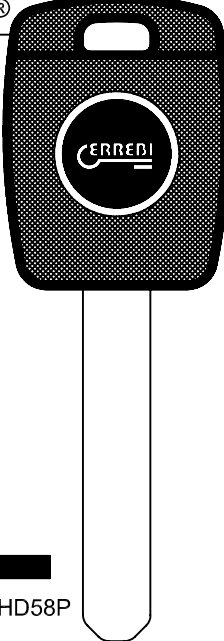

SISTEMA DI GESTIONE
QUALITÀ CERTIFICATO

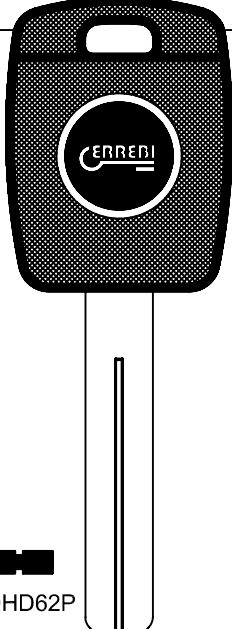
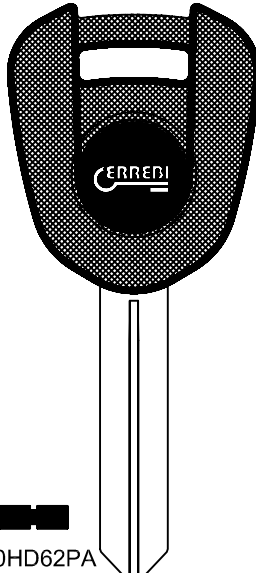
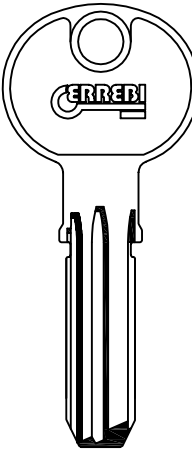

FOR: G.-T.-S.®	FOR: GIUSSANI®	FOR: HB®	FOR: HOK®
			
 T00GB18P	 GU12	 HBO1	 HOK1

FOR: HONDA®		FOR: HONDA®	
			
 HD44P93	 HD58P	 T00HD58P	

FOR: HONDA®		FOR: HTEC®
		
 T00HD62P	 T00HD62PA	 HTE1

PER / FOR

GIOBERT-TRW-SIPEA® (IT)
 GIUSSANI® (IT)
 HB® (IT)
 HOK® (TR)
 HONDA® (JP)
 HTEK® (ES)



Copyright by
 Errebi s.p.a. Unipersonale 2018

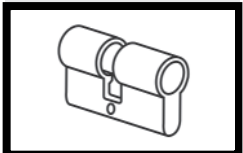

PER / FOR

HUF® (DE)

FOR: HUF®

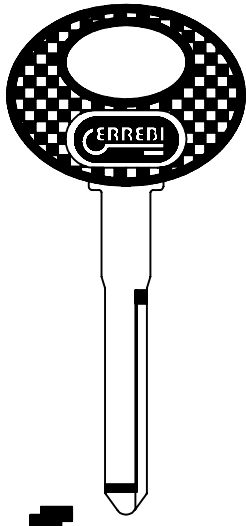

HF38AP18

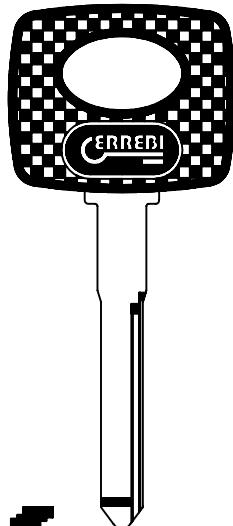

HF38P17

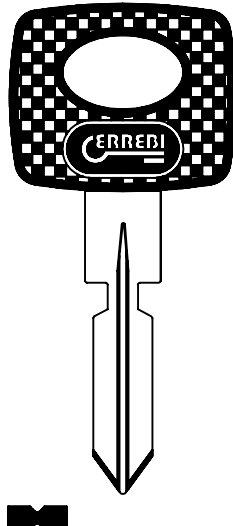

HF39P17

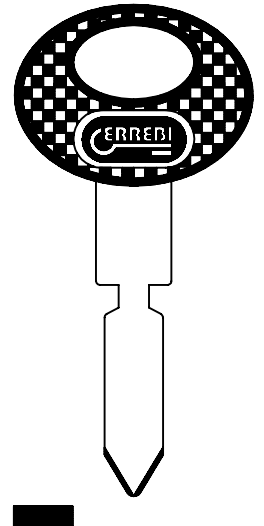

HF40P18

FOR: HUF®



HF42C1

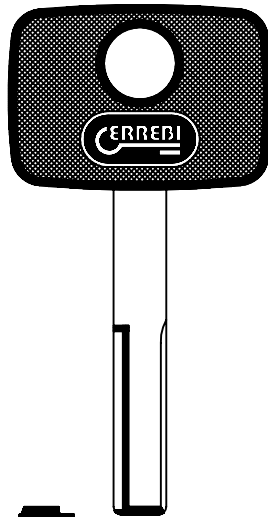

HF42P15

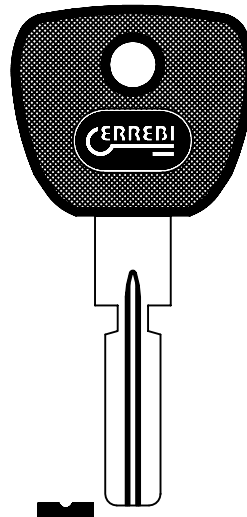

HF48P8

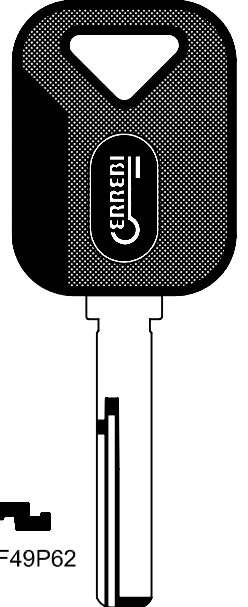

HF49P62

FOR: HUF®

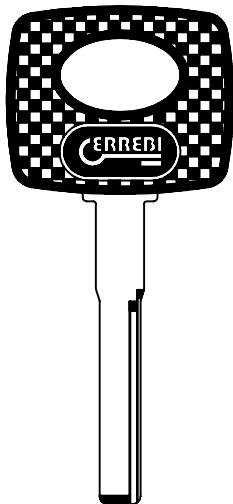

HF51P17

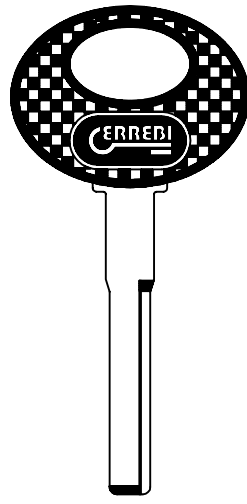

HF52P18

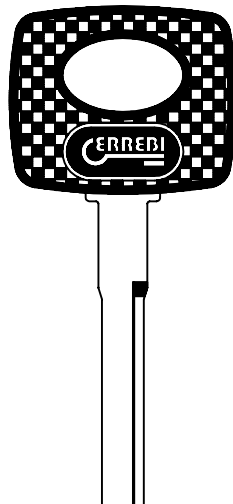

HF53P17

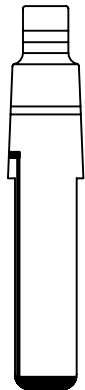

HF55C1

ERREBI

Copyright by
Errebi s.p.a. Unipersonale 2018

UNI EN ISO 9001:2008



SISTEMA DI GESTIONE
QUALITÀ CERTIFICATO

CERTIQUALITY
È MEMBRO DELLA
FEDERAZIONE CISO

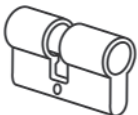

FOR: HUF ®

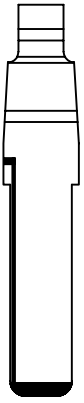

HF55C2

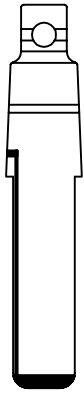

HF55C3

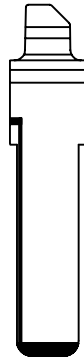

HF55C4



HF55C5

FOR: HUF ®

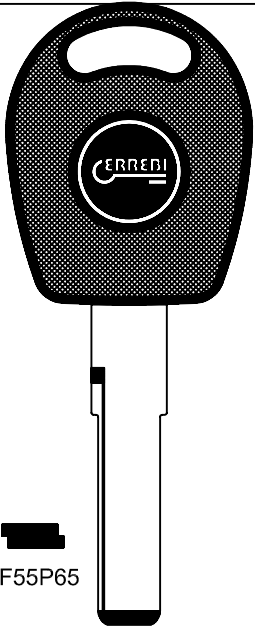

HF55P65

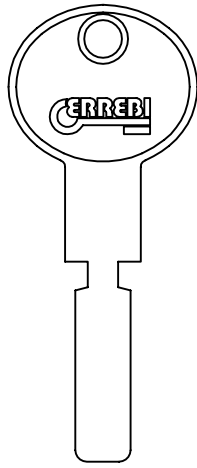

HF57

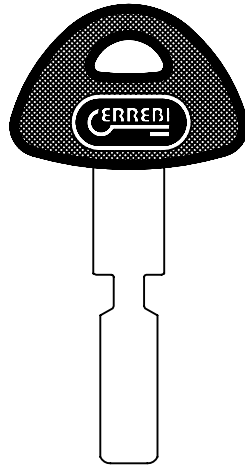

HF59P150

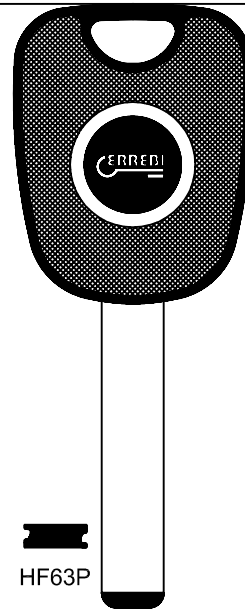

HF63P

FOR: HUF ®

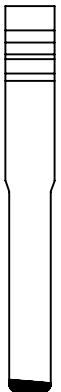

HF65C1

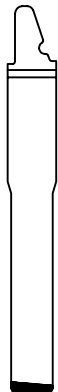

HF65C2

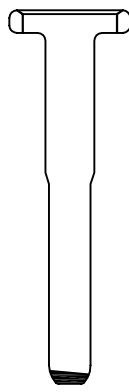

HF65C3

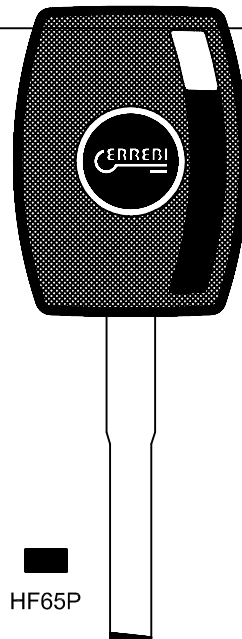

HF65P

PER / FOR

HUF® (DE)



Copyright by
Errebi s.p.a. Unipersonale 2018

UNI EN ISO 9001:2008



SISTEMA DI GESTIONE
QUALITÀ CERTIFICATO

CERTIQUALITY
È MEMBRO DELLA
FEDERAZIONE CISO

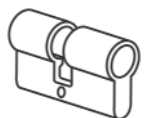

PER / FOR

HUF® (DE)

FOR: HUF®



HF66C1

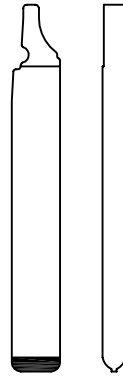

HF66C3

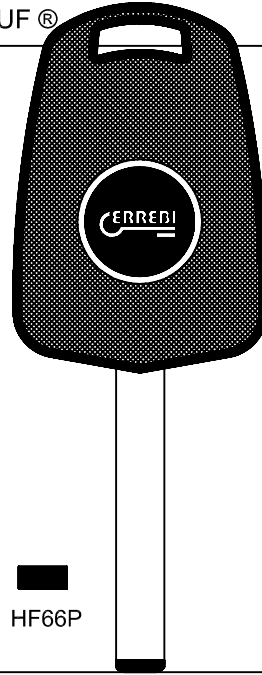

HF66P

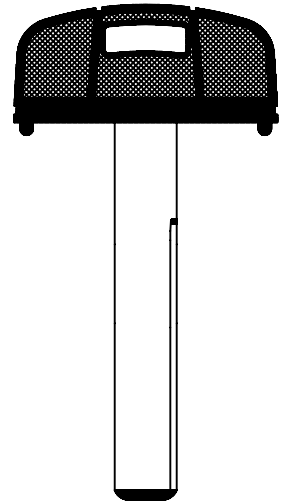

HF70P

FOR: HUF®

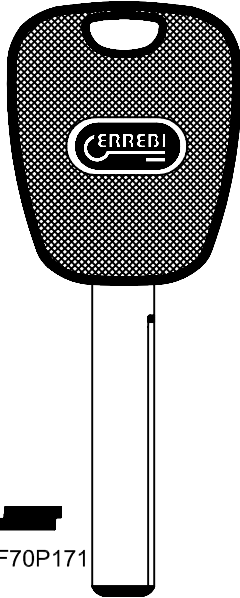

HF70P171

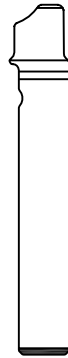

HF73C1

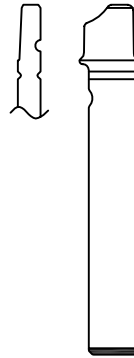

HF74C1

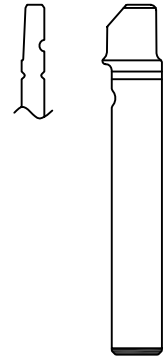

HF75C1

FOR: HUF®

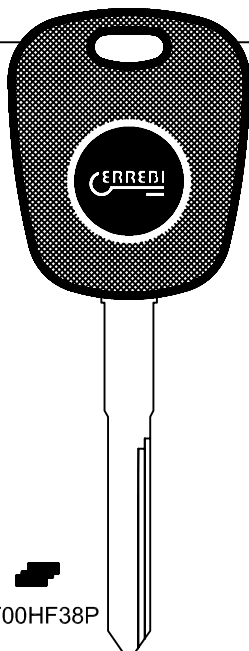

T00HF38P

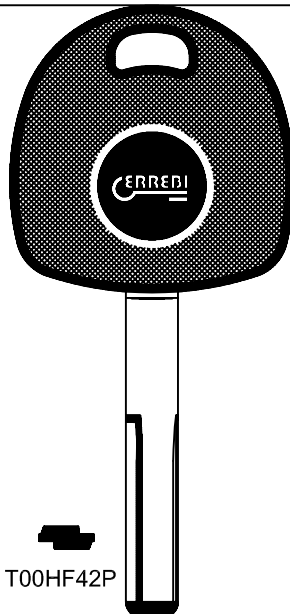

T00HF42P

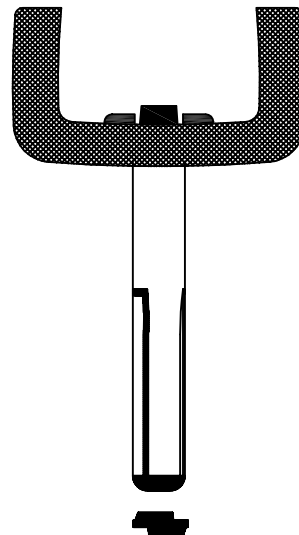

T00HF42PA

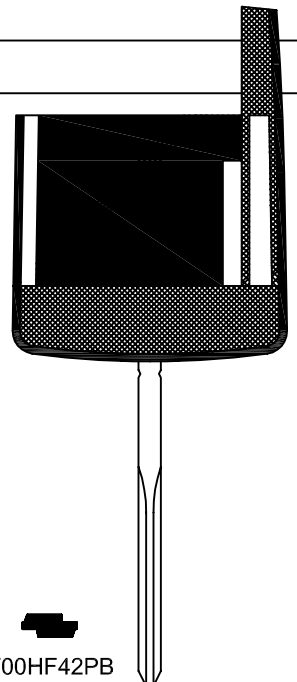

T00HF42PB

ERREBI

Copyright by
Errebi s.p.a. Unipersonale 2018

UNI EN ISO 9001:2008



SISTEMA DI GESTIONE
QUALITÀ CERTIFICATO

CERTIQUALITY
È MEMBRO DELLA
FEDERAZIONE CISO

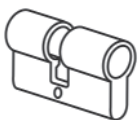

FOR: HUF®

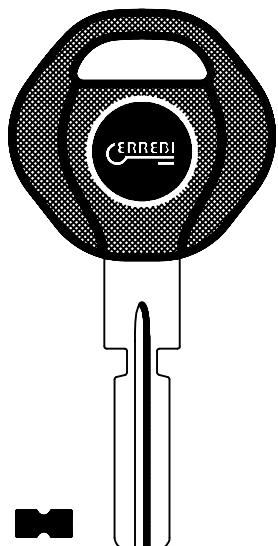

T00HF48P

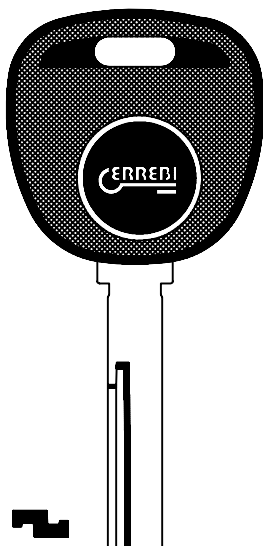

T00HF49P

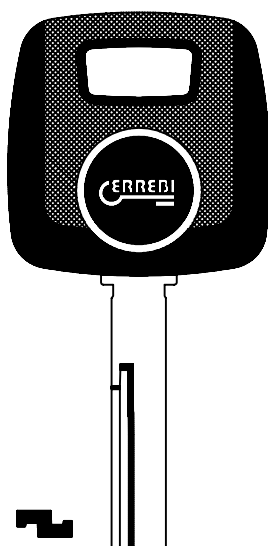

T00HF49PA

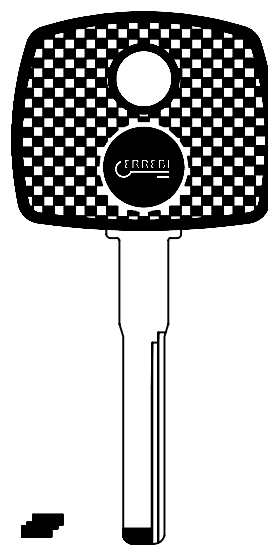

T00HF51P

FOR: HUF®

FOR: HUF®

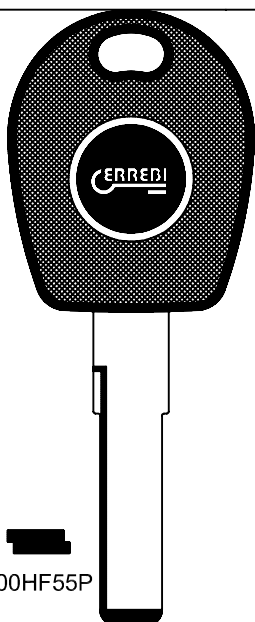

T00HF55P

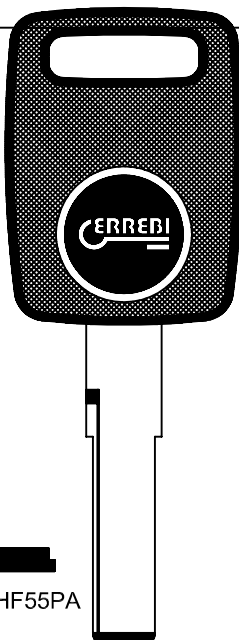

T00HF55PA

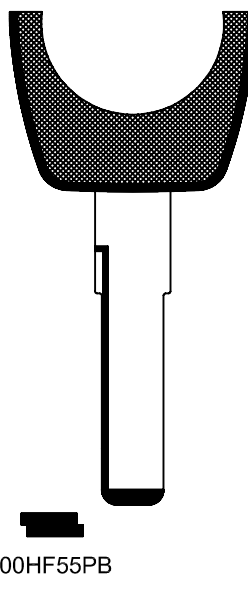

T00HF55PB

FOR: HUF®

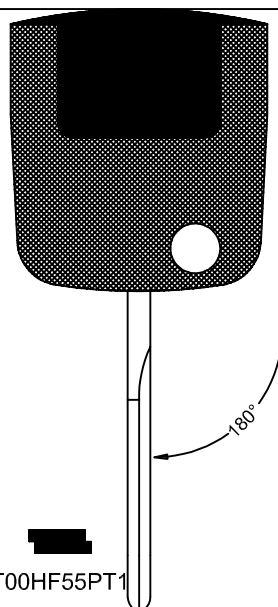

T00HF55PT1

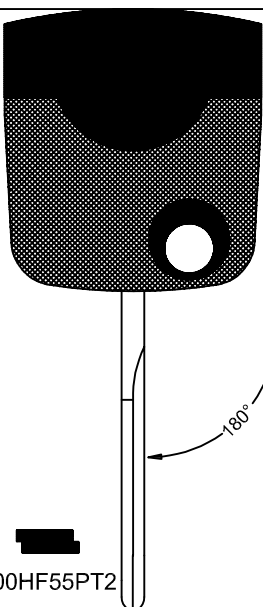

T00HF55PT2

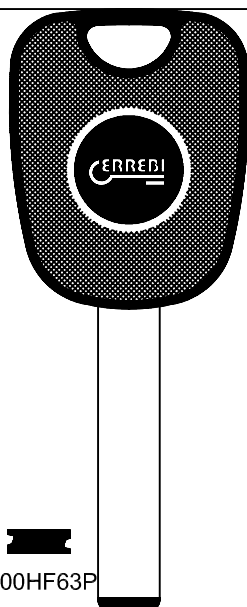

T00HF63P

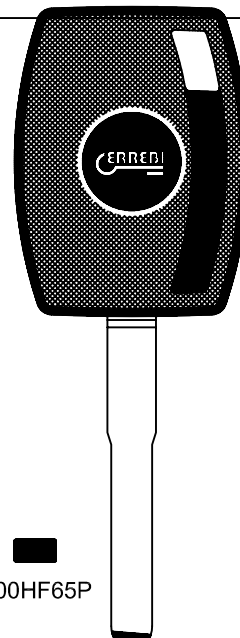

T00HF65P

PER / FOR

HUF® (DE)



Copyright by Errebi s.p.a. Unipersonale 2018

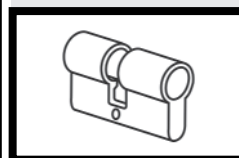

PER / FOR

HUF® (DE)

FOR: HUF®

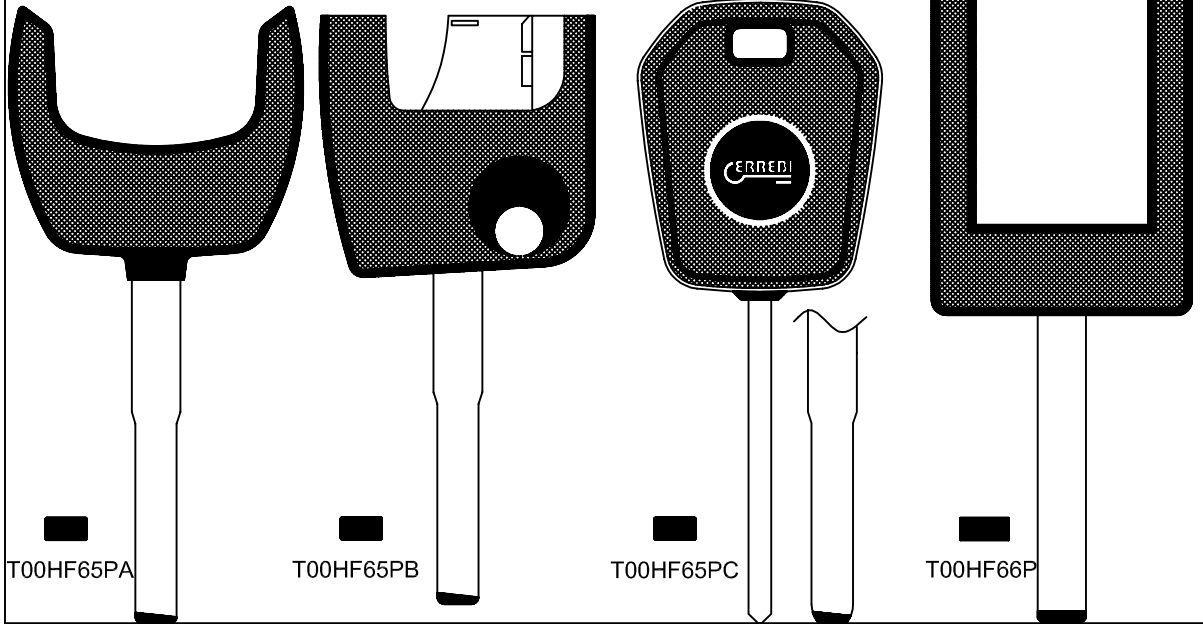

T00HF65PA

T00HF65PB

T00HF65PC

T00HF66P

FOR: HUF®

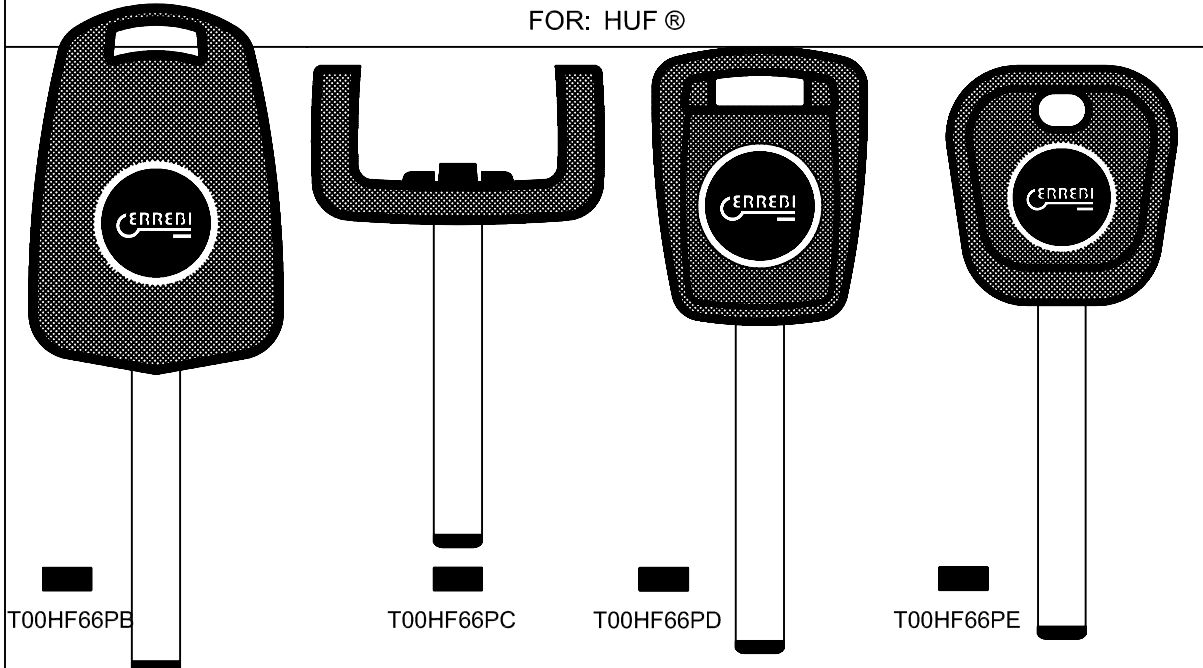

T00HF66PB

T00HF66PC

T00HF66PD

T00HF66PE

FOR: HUF®

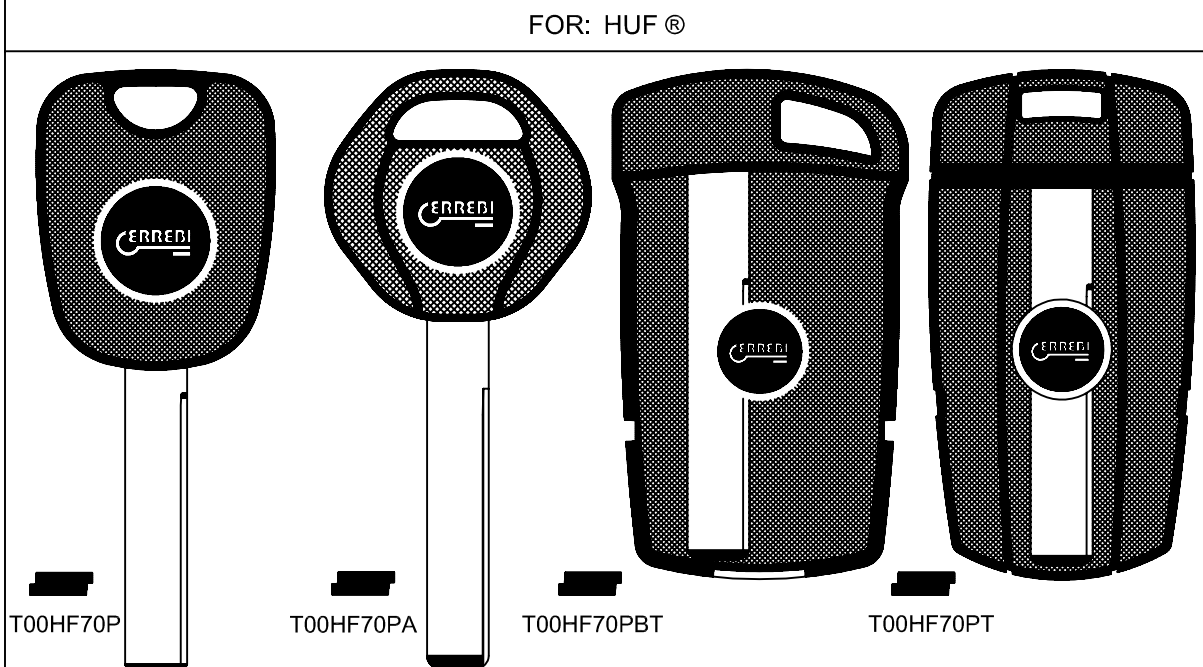

T00HF70P

T00HF70PA

T00HF70PBT

T00HF70PT



Copyright by
Errebi s.p.a. Unipersonale 2018

UNI EN ISO 9001:2008



SISTEMA DI GESTIONE
QUALITÀ CERTIFICATO

CERTIQUALITY
È MEMBRO DELLA
FEDERAZIONE CISO

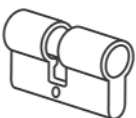

FOR: HUF®

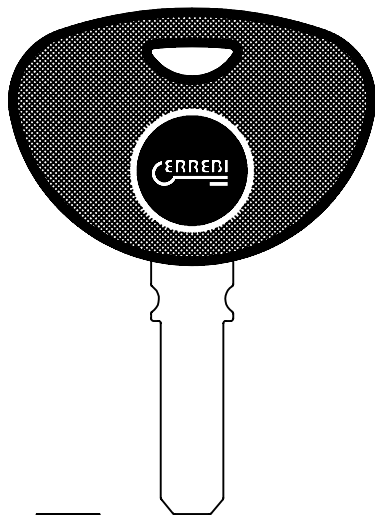

T00HF71P

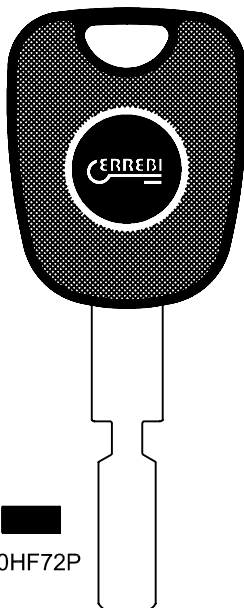

T00HF72P

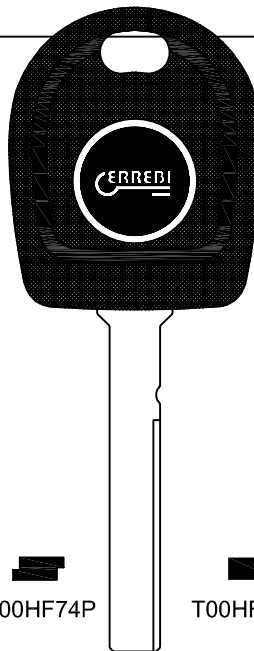

T00HF74P

T00HF75P

PER / FOR

- HUF® (DE)
- HUGO® (DE)
- HYUNDAI® (KR)
- IBFM® (IT)

FOR: HUGO®

FOR: HYUNDAI®

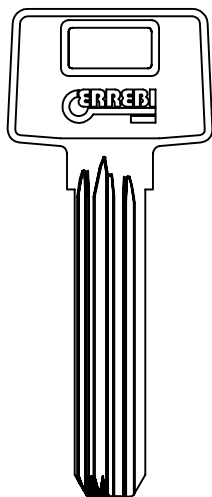

HGO1

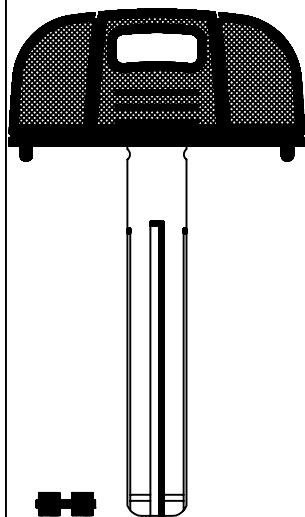

HYN13P



HYN14C1

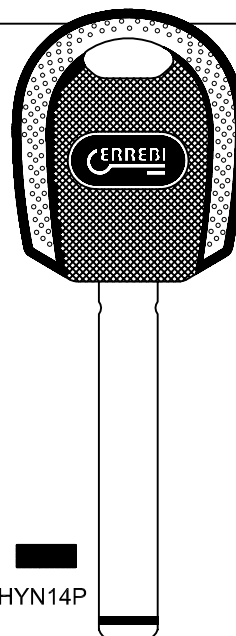

HYN14P

FOR: HYUNDAI®

FOR: IBFM®

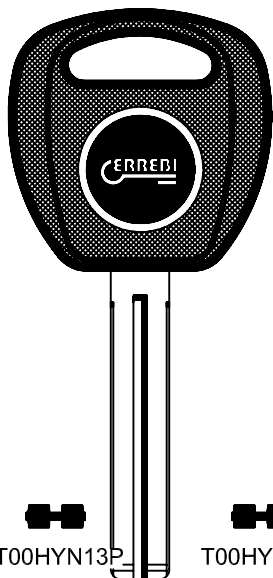

T00HYN13P

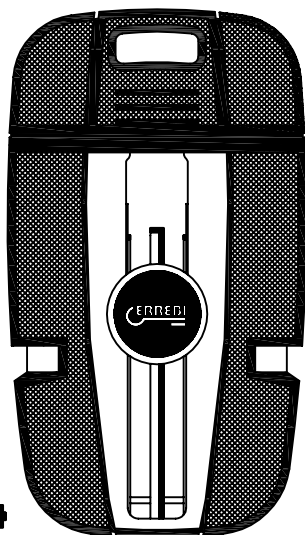

T00HYN13T

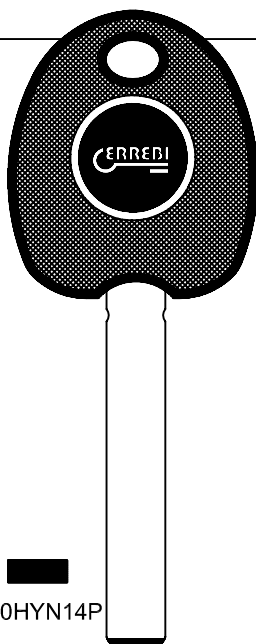

T00HYN14P

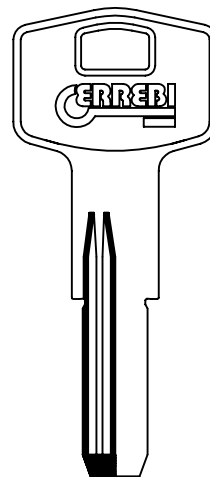

IBF2R



Copyright by Errebi s.p.a. Unipersonale 2018

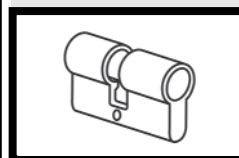

PER / FOR

IFAM® (ES)
INCECA® (ES)
IR® (FR)
ISEO® (IT)

FOR: IFAM®

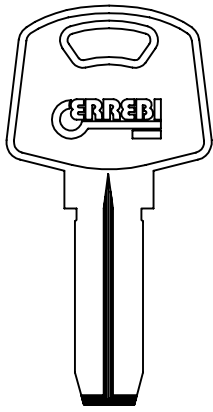

IF2

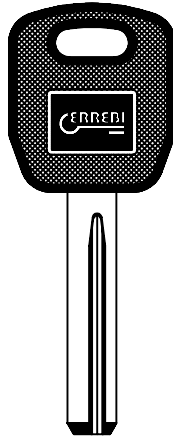

IF10P149

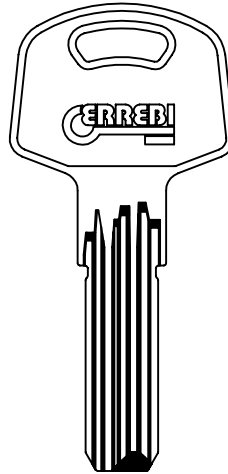

IF12

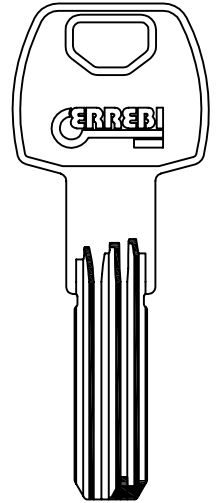

IF13

FOR: IFAM®

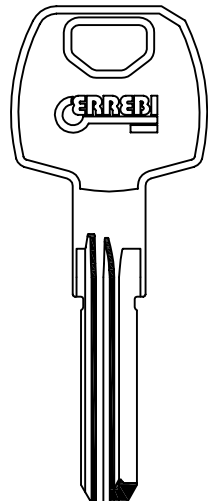

IF14

FOR: INCECA®

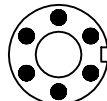

INC1T



INC2T

FOR: IR®

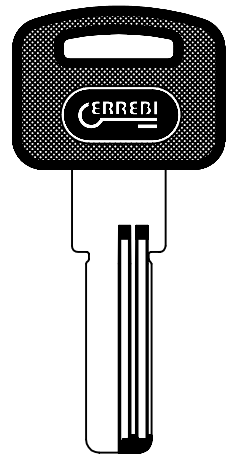

IR1P164

FOR: ISEO®

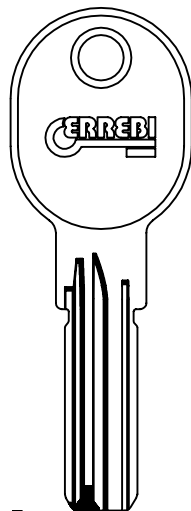

I15

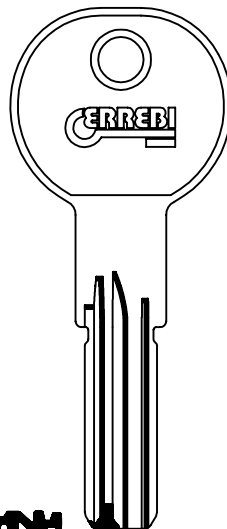

I16

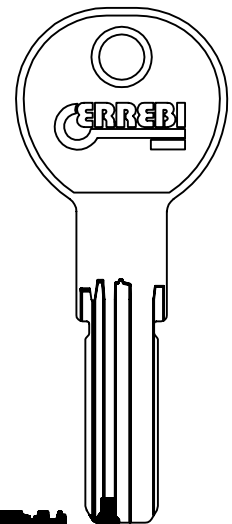

I20



Copyright by
Errebi s.p.a. Unipersonale 2018





UNI EN ISO 9001:2008

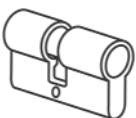

SISTEMA DI GESTIONE
QUALITÀ CERTIFICATO

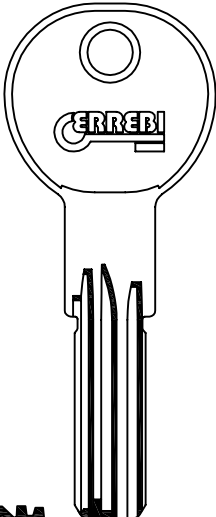
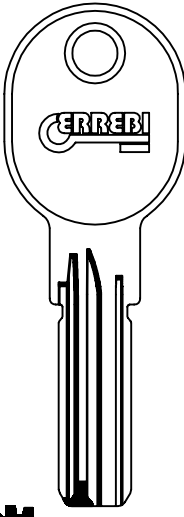
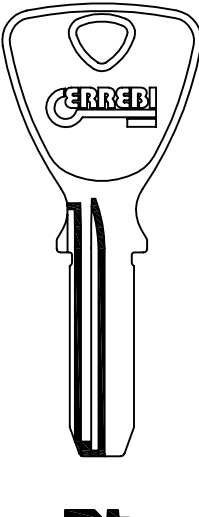
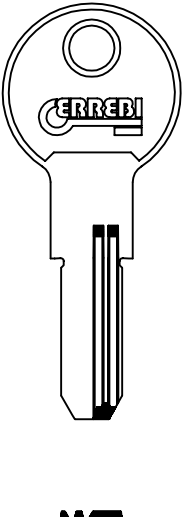
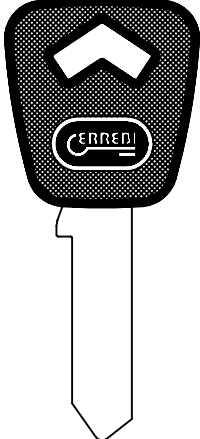
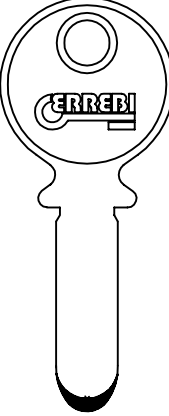
CERTIQUALITY
È MEMBRO DELLA
FEDERAZIONE CISO

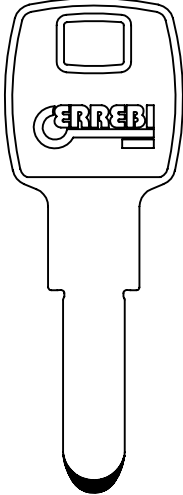
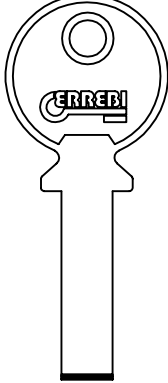
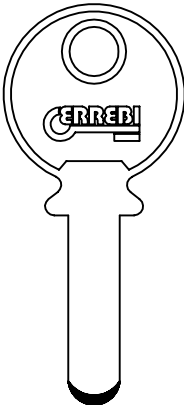
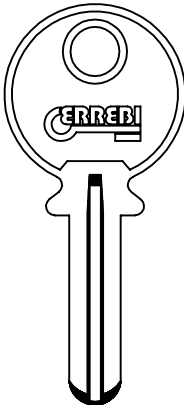

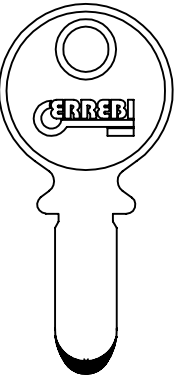
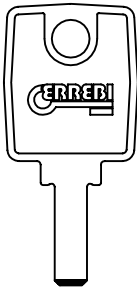
FOR: ISEO®	FOR: ITO®	FOR: JAGUAR®
 <p>I22</p>	 <p>ITO2</p>  <p>ITO3</p>	 <p>JAG1</p>
FOR: JIS®	FOR: KABA®	
 <p>JIS4P</p>	 <p>KB1</p>  <p>KB2</p>  <p>KB2N</p>	 <p>KB3</p>
FOR: KABA®		
 <p>KB3N</p>	 <p>KB4</p>  <p>KB5</p>	 <p>KB6</p>  <p>KB7</p>

PER / FOR

- ISEO® (IT)
- ITO® (TR)
- JAGUAR® (ZA)
- JIS® (ES)
- KABA® (CH)



Copyright by Errebi s.p.a. Unipersonale 2018

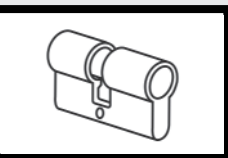

PER / FOR

KALE® (TR)

KESO® (CH)

FOR: KALE®



KAL2

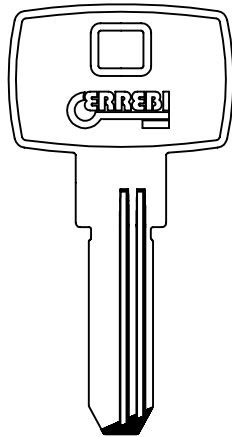

KAL3

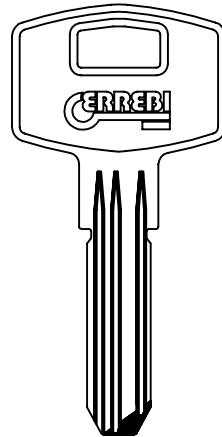

KAL4

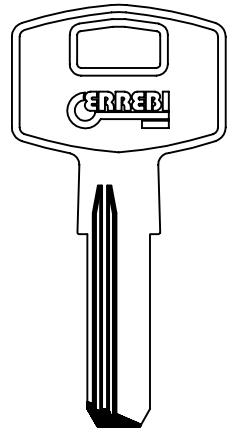

KAL7

FOR: KALE®

FOR: KESO®

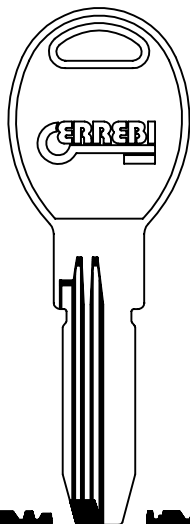

KAL11

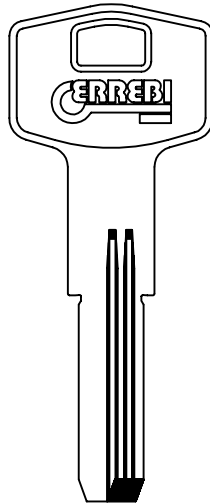

KAL12

KAL13

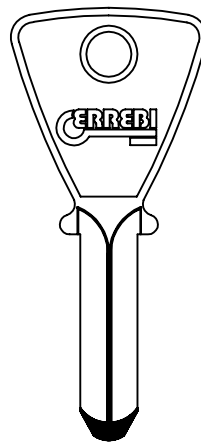

KC1

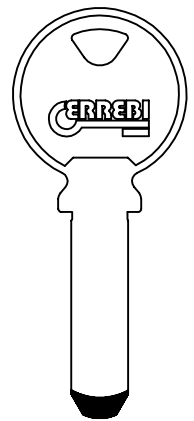

KC2

FOR: KESO®

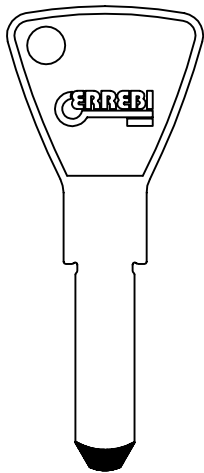

KC2T

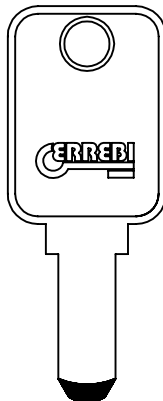

KC3

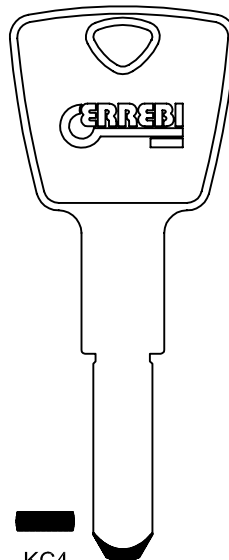

KC4

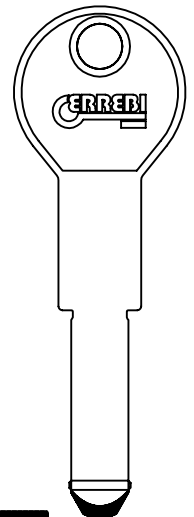

KC5



Copyright by
Errebi s.p.a. Unipersonale 2018

UNI EN ISO 9001:2008



SISTEMA DI GESTIONE
QUALITÀ CERTIFICATO

CERTIQUALITY
È MEMBRO DELLA
FEDERAZIONE CISO

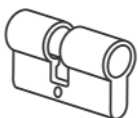

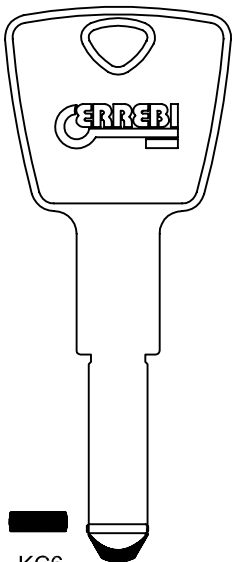
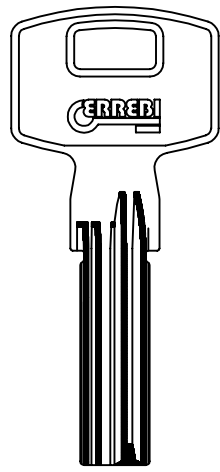
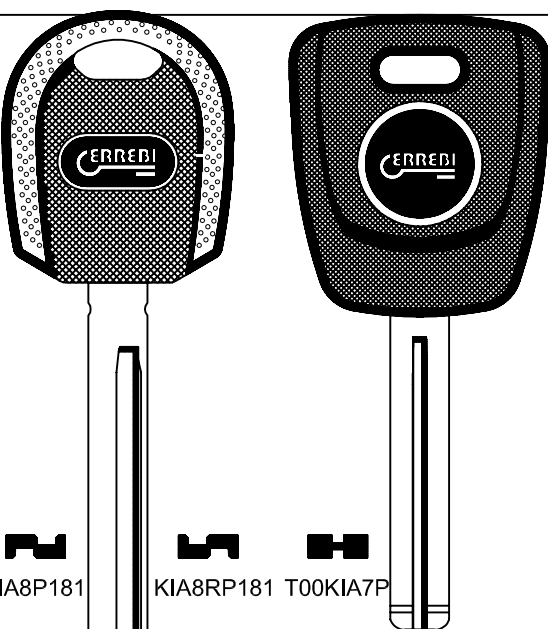
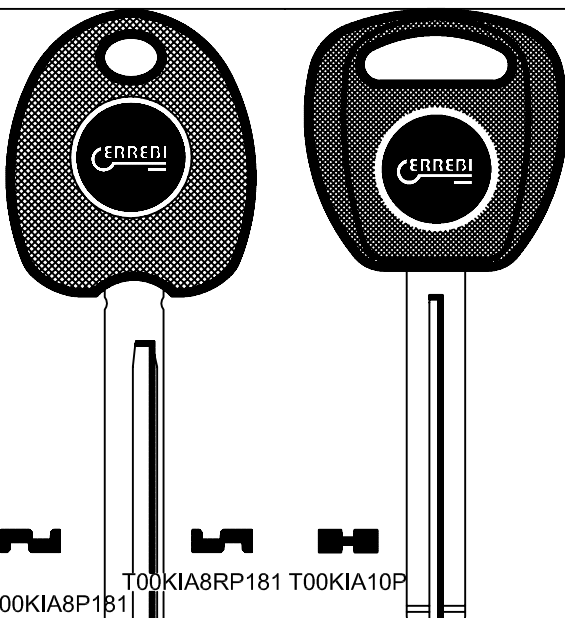
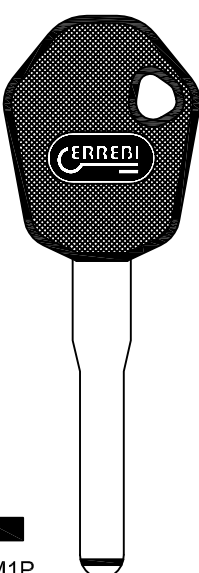
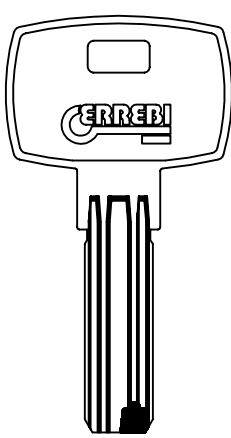
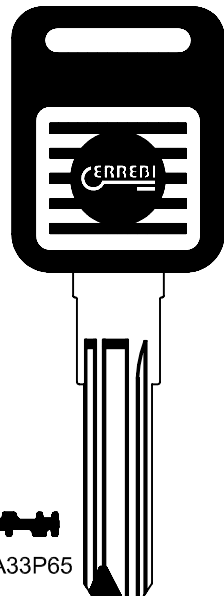
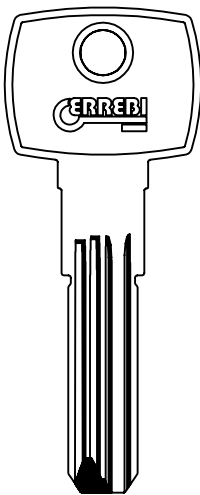
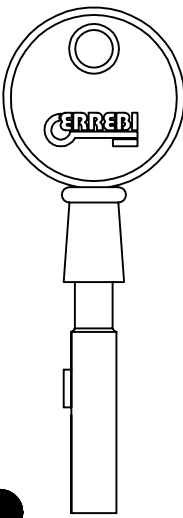
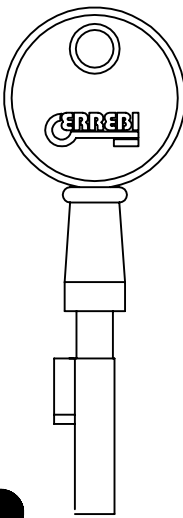
<p>FOR: KESO®</p>  <p>KC6</p>	<p>FOR: KFV-FCV®</p>  <p>KF4</p>	<p>FOR: KIA®</p>  <p>KIA8P181 KIA8RP181 T00KIA7P</p>	
<p>FOR: KIA®</p>  <p>T00KIA8P181 T00KIA8RP181 T00KIA10P</p>		<p>FOR: KTM®</p>  <p>KM1P</p>	<p>FOR: LAPERCHE®</p>  <p>LA31</p>
<p>FOR: LAPERCHE®</p>			
 <p>LA33P65</p>	 <p>LA40</p>	 <p>LP610</p>	 <p>LP620</p>

PER / FOR

- KESO® (CH)
- KFV-FC® (DE)
- KIA® (KR)
- KTM® (AT)
- LAPERCHE® (FR)



Copyright by
Errebi s.p.a. Unipersonale 2018

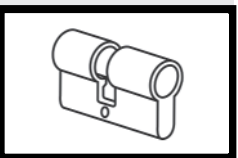

PER / FOR

- LINCE® (ES)
- LOCKSYS® (BG)
- LT® (CN)
- LYF® (ES)
- MAGNUM® (GB)
- MAHINDRA® (IN)
- MASTER® (US)
- MASTER LOCK® (CN)

FOR: LINCE®

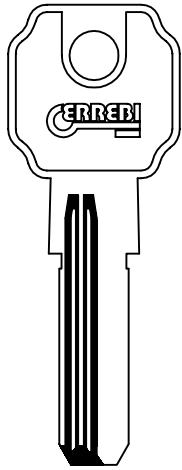

 LI9R

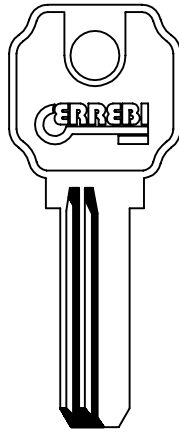

 LI16R

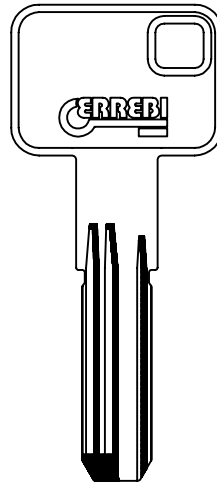

 LI17

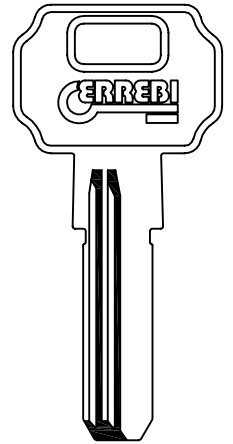

 LI18R

FOR: LOCKSYS®

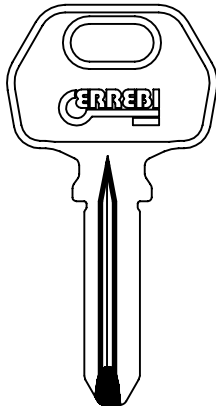

 LKS1

FOR: LT®

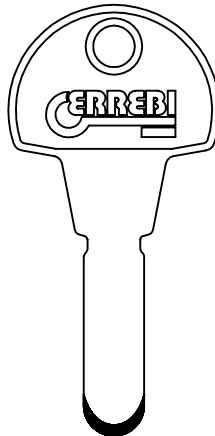

 LT1

FOR: LYF®

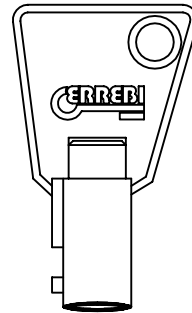

 LYF2T

FOR: MAGNUM®

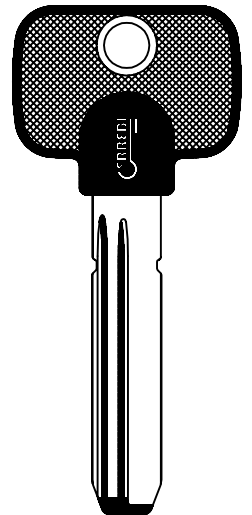

 MGN1RP176

FOR: MAGNUM®

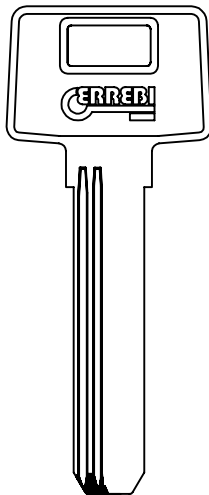

 MGN2R

FOR: MASTER®

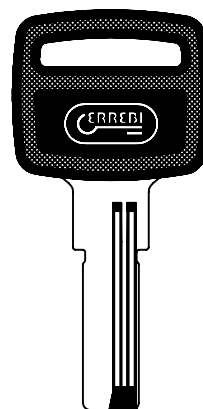

 M19P154

FOR: MASTER LOCK®

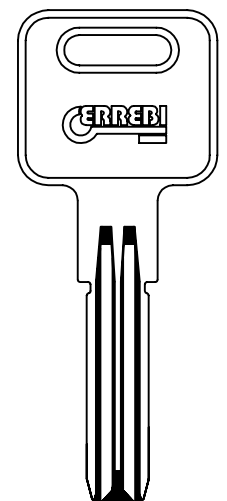

 MAS1

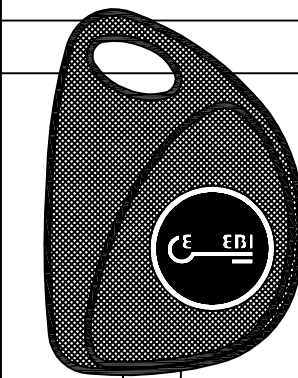

FOR: MAHINDRA®

 T00MHN1P



Copyright by
Errebi s.p.a. Unipersonale 2018

UNI EN ISO 9001:2008



SISTEMA DI GESTIONE
QUALITÀ CERTIFICATO

CERTIQUALITY
È MEMBRO DELLA
FEDERAZIONE CISO

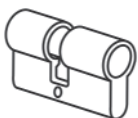

FOR: MASTER LOCK®

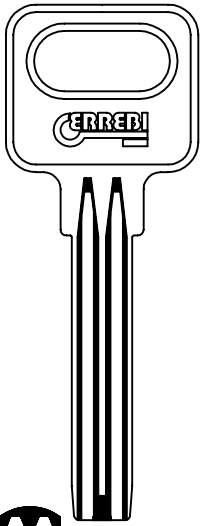

MAS2

FOR: MAUER®

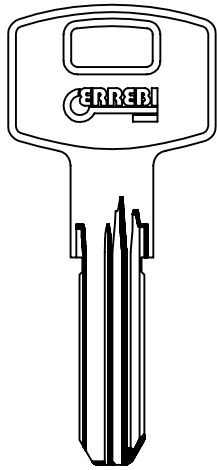

MAU4

FOR: MAZDA®

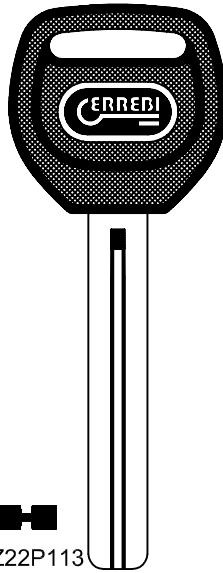

MZ22P113

FOR: MCM®

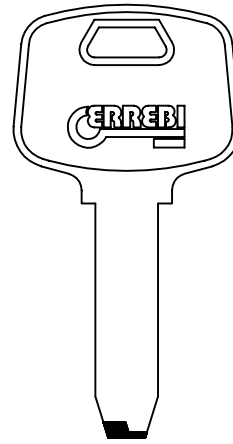

MD12

MD25

PER / FOR

MASTER LOCK® (CN)
MAUER® (BG)
MAZDA® (JP)
MCM® (ES)
MERONI® (IT)

FOR: MCM®

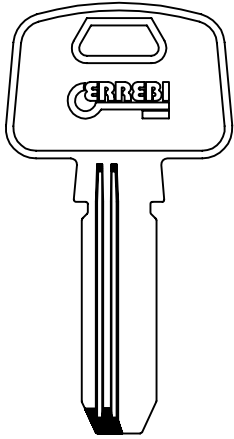

MD13R

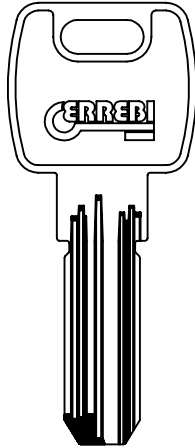

MD17

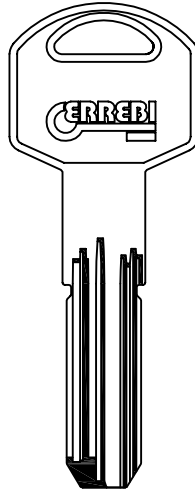

MD26

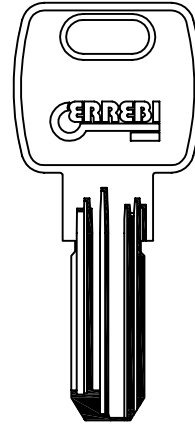

MD27

FOR: MERONI®

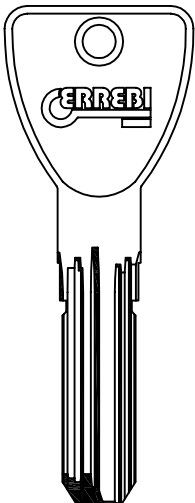

MD30

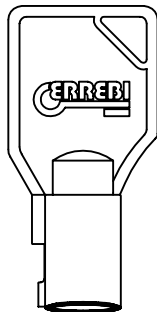

MR23T

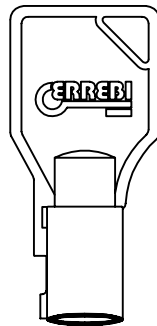

MR24T

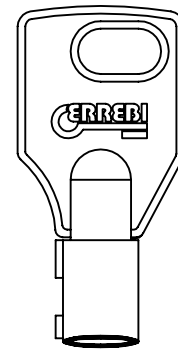

MR26T



Copyright by
Errebi s.p.a. Unipersonale 2018

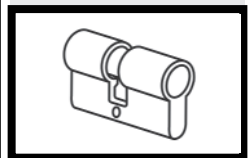

PER / FOR

- MERONI® (IT)
- MHA® (TJ)
- MILES®
- MLM® (DE)
- MOIA® (IT)
- MONTI-MG® (IT)

FOR: MERONI®

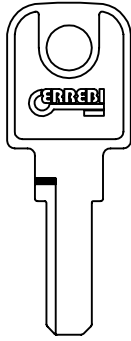

FOR: MHA®

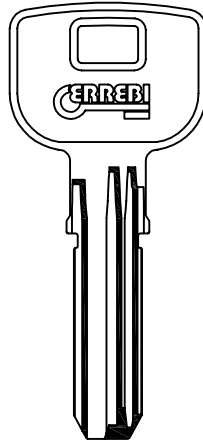

FOR: MILES®

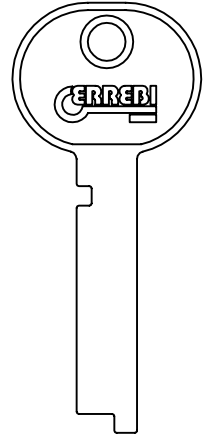
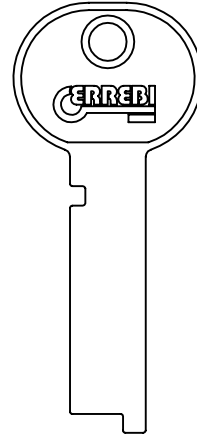

FOR: MLM®

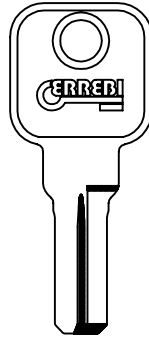
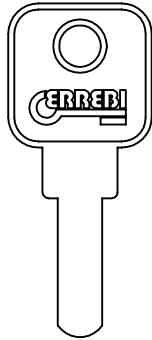

FOR: MOIA®

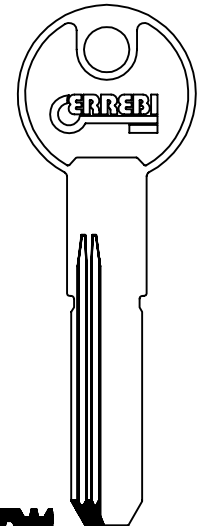
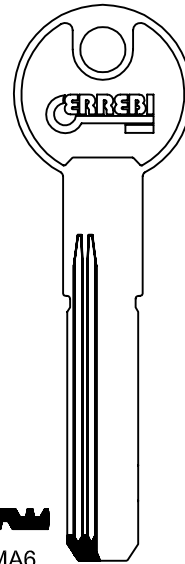

FOR: MOIA®

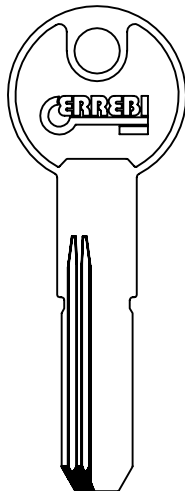

FOR: MONTI®

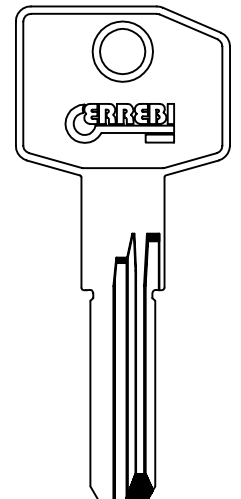
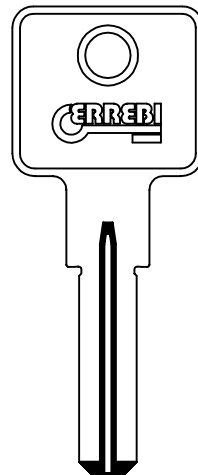

Copyright by
Errebi s.p.a. Unipersonale 2018

UNI EN ISO 9001:2008



CERTIQUALITY
È MEMBRO DELLA
FEDERAZIONE CISO



SISTEMA DI GESTIONE
QUALITÀ CERTIFICATO

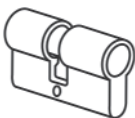

FOR: MOTTURA®

FOR: MSM®

PER / FOR

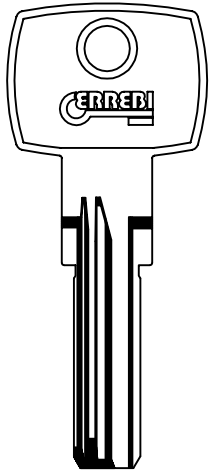

 MO3

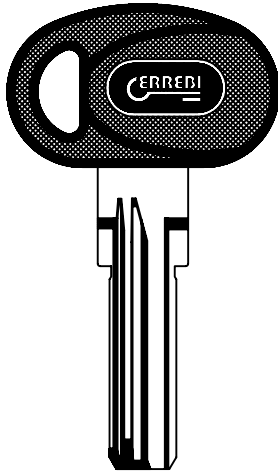

 MO3P179

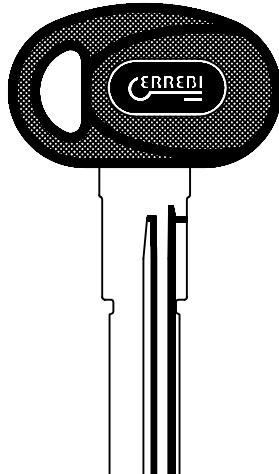

 MO4P179

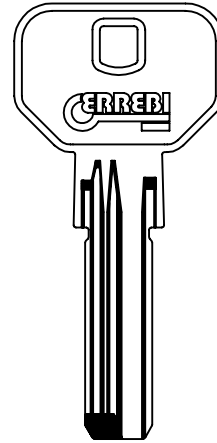

 MSM1

MOTTUR® (IT)
MSM®
MUL-T-LOCK® (IL)

FOR: MUL-T-LOCK®

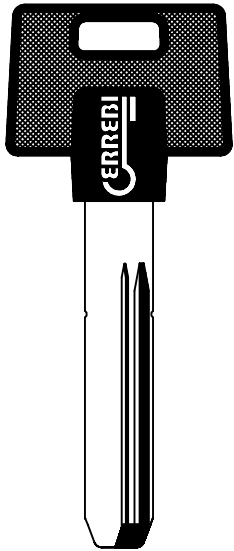

 MLT1P76

 MLT1RP76

 MLT1RDSP76

 MLT3P76

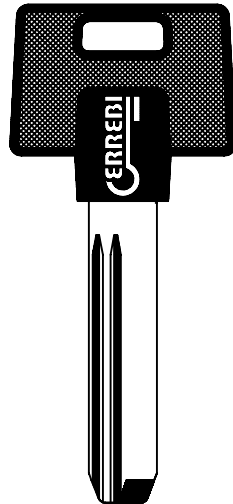

 MLT2RP76

 MLT7RP76

FOR: MUL-T-LOCK®

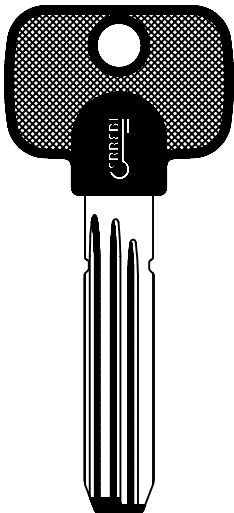

 MLT8RP176

 MLT9RP176

 MLT10RP176

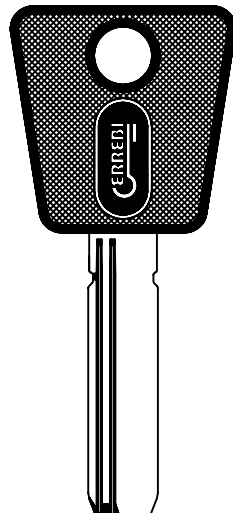

 MLT11RP169

 MLT12RP169

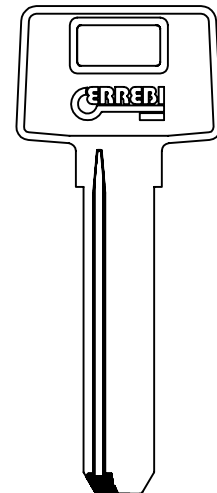

 MLT14R



Copyright by
Errebi s.p.a. Unipersonale 2018

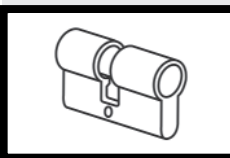

PER / FOR

MUL-T-LOCK® (IL)
 NEIMAN® (FR)
 NOORI® (DE)
 OJMAR® (ES)

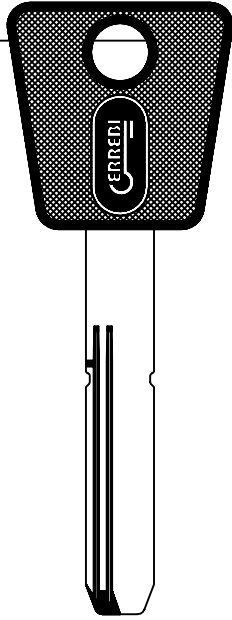

FOR: MUL-T-LOCK®

 MLT13RP169

Tx7
 MLT15RP169

JUNIOR
 MLT16RP169

FOR: NEIMAN®

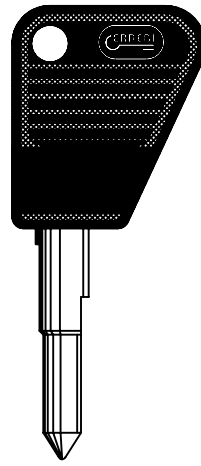

NE33P66

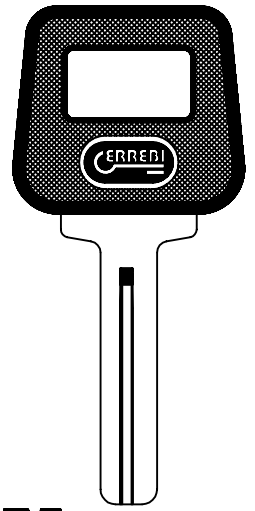

NE70P70

FOR: NEIMAN®

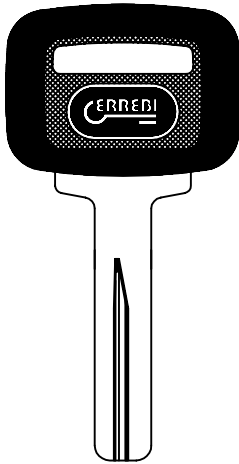

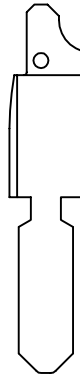

 NE71P71

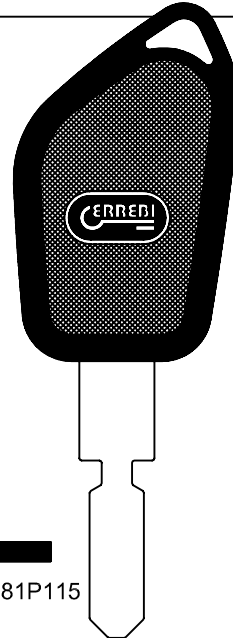

 NE81C1



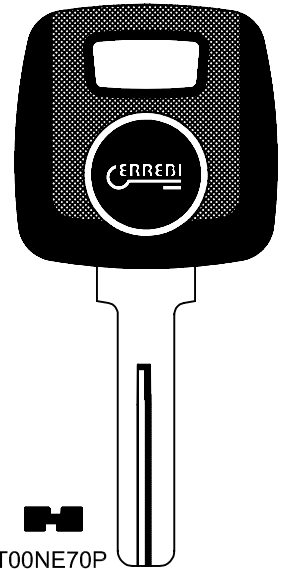

 NE81P115



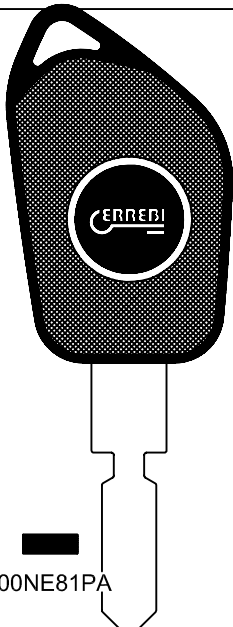

 T00NE70P

FOR: NEIMAN®



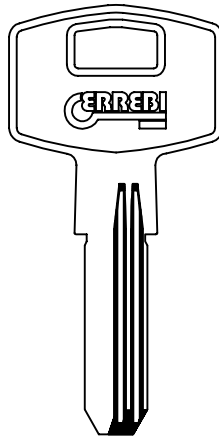

 T00NE81PA

FOR: NOORI®

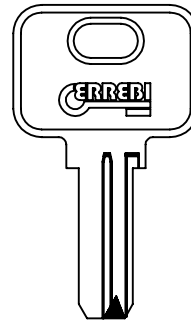

 NOR1
 NOR1R

FOR: OJMAR®



 OJ22

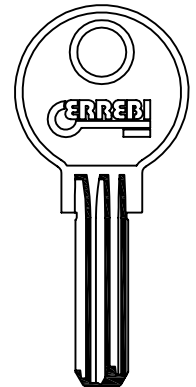

 OJ27



Copyright by
 Errebi s.p.a. Unipersonale 2018

UNI EN ISO 9001:2008



SISTEMA DI GESTIONE
 QUALITÀ CERTIFICATO

CERTIQUALITY
 È MEMBRO DELLA
 FEDERAZIONE CISO

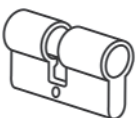

FOR: OMEC®

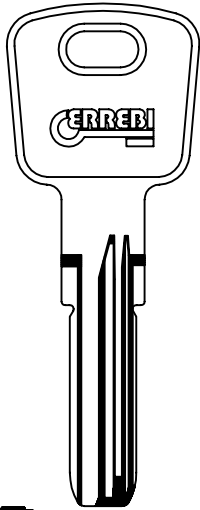

O7

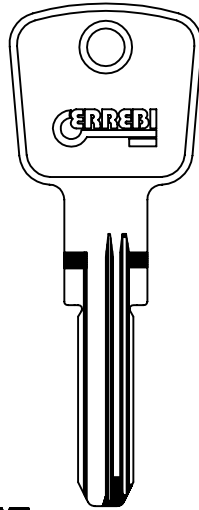

O8

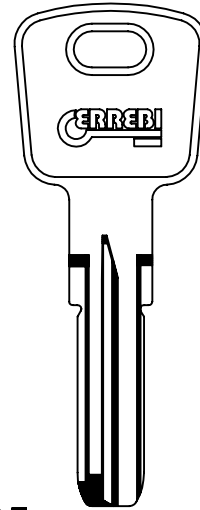

O11

FOR: P.C.(Cortellezzi)®

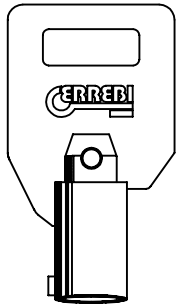

PA6T



PA7T

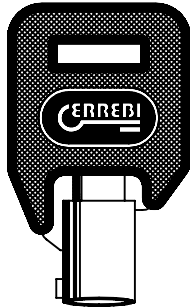

PA6TP

FOR: PENZA®

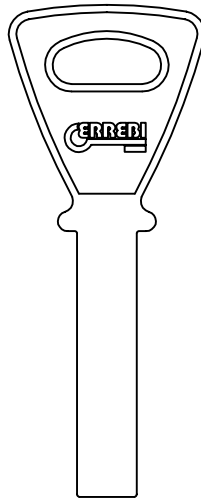

PNZ2

FOR: PERINO®

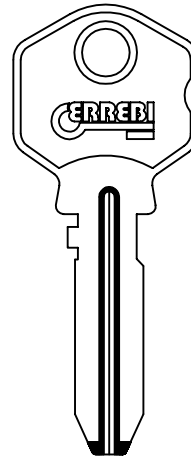

PR2

FOR: PFAFFENHAIN®

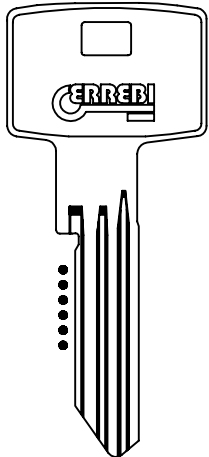

PH14R



PH15R



PH16R



PH17R



PH18



PH19



PH19R



PH21R



PH22R



PH26



PH27



PH28



PH29



PH29R



PH30R



PH31



PH32

PER / FOR

- OMEC® (IT)
- P.C.® (IT)
- PENZA® (RU)
- PERINO® (IT)
- PFAFFENHAIN® (DE)



Copyright by
Errebi s.p.a. Unipersonale 2018

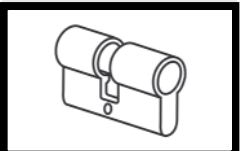

PER / FOR

- PICARD® (FR)
- POTENT® (IT)
- PREFER® (IT)
- RIL® (PT)
- ROSSETTI® (RO)
- SEA® (CH)
- SECUREMME® (IT)

FOR: PICARD®

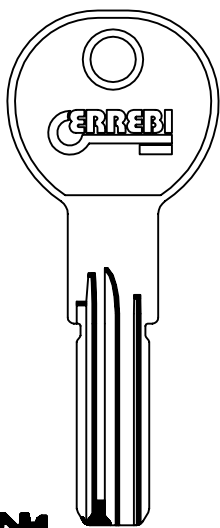

PIC1

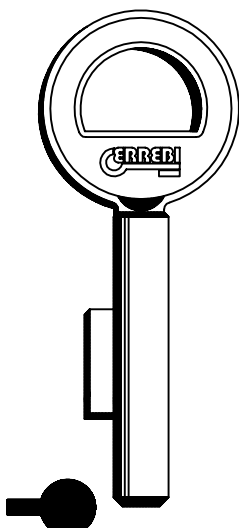

VP1

FOR: POTENT®

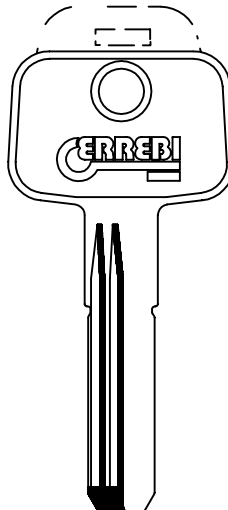

PN1R

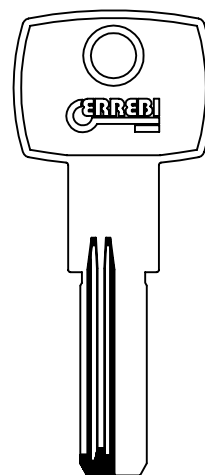

PN3R

FOR: POTENT®

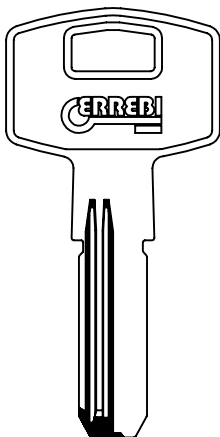

PN5R

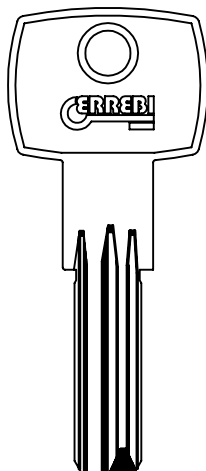

PN7

FOR: PREFER®

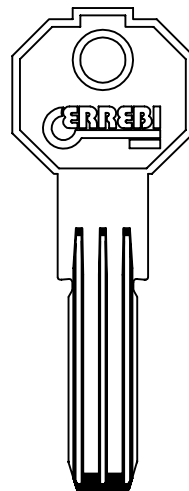

P15

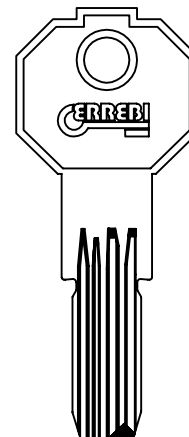

P17

FOR: RIL®

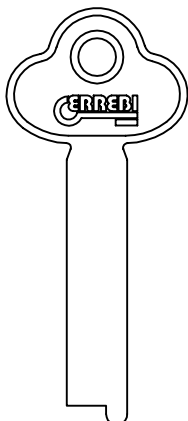

RL1

FOR: ROSSETTI®

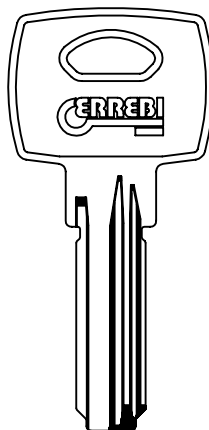

ROS1

FOR: SEA®

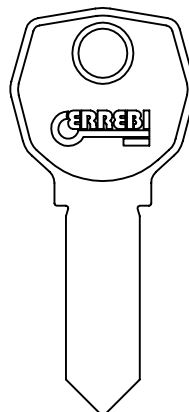

SE1L

FOR: SECUREMME®

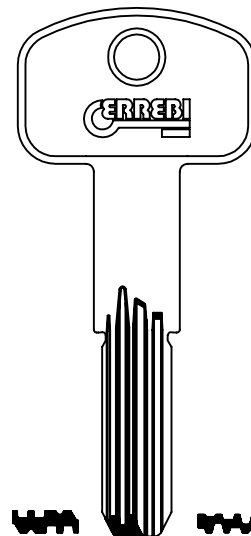

SEM7

SEM8



Copyright by
Errebi s.p.a. Unipersonale 2018

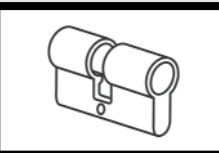

FOR: SECUREMME®	FOR: SECURITAL®
<p>SEM8P SEM10P</p>	<p>SCU1 SCU2</p>

PER / FOR

SECUREMME® (IT)
SECURITAL® (IT)
SERRETA® (ES)
SIMPLEX® (FR)
SMART® (DE)
SPIDER® (IL)
STS® (ES)

FOR: SERRETA®	FOR: SIMPLEX®		
<p>SRT1</p>	<p>SM7P68</p>	<p>SM7P74</p>	<p>SM7P145</p>

FOR: SIMPLEX®	FOR: SMART®	FOR: SPIDER®	FOR: STS®
<p>T00SM7P</p>	<p>T00SMR1P</p>	<p>SPR2</p>	<p>STS1N STS1NR</p>



Copyright by
Errebi s.p.a. Unipersonale 2018

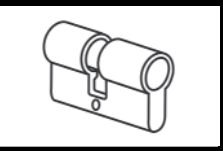

PER / FOR

- STS® (ES)
- SUBARU® (JP)
- TARONI® (IT)
- TECSESA® (ES)
- TESA® (ES)

FOR: STS®

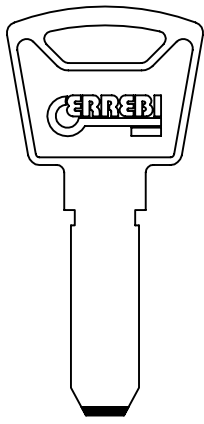

 STS5

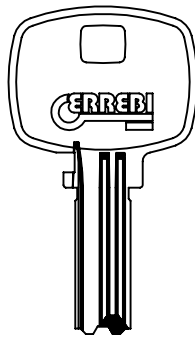

 STS10

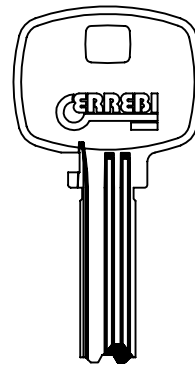

 STS11

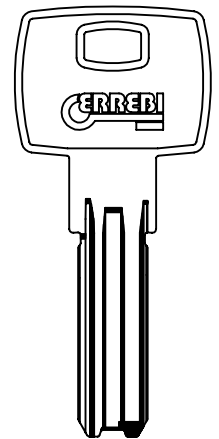

 STS12

FOR: STS®

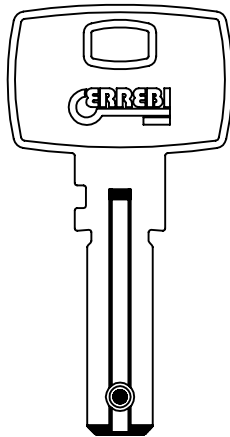

 STS15

FOR: SUBARU®

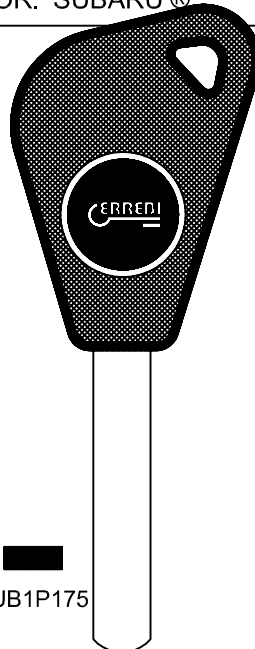

 SUB1P175

FOR: TARONI®

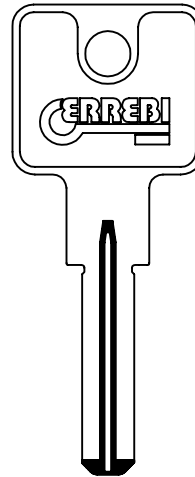

 T7

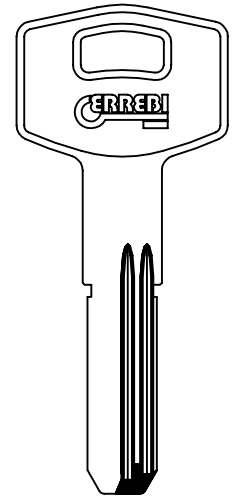

 T8  T8R

FOR: TARONI®

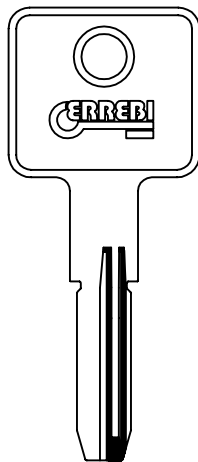

 T10

FOR: TECSESA®

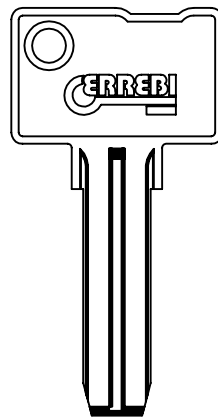

 TCS1

FOR: TESA®

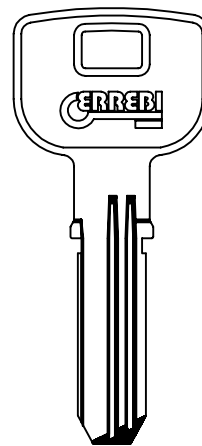

 TS12

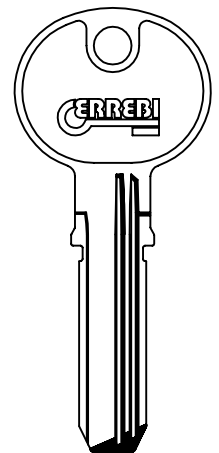

 TS14



Copyright by Errebi s.p.a. Unipersonale 2018

UNI EN ISO 9001:2008



SISTEMA DI GESTIONE QUALITÀ CERTIFICATO

CERTIQUALITY È MEMBRO DELLA FEDERAZIONE CISO

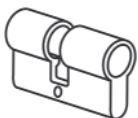

FOR: TESA®

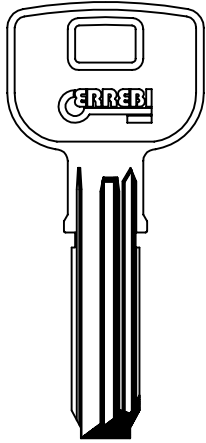

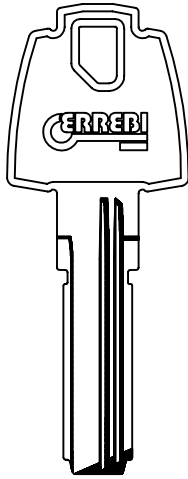

TS15

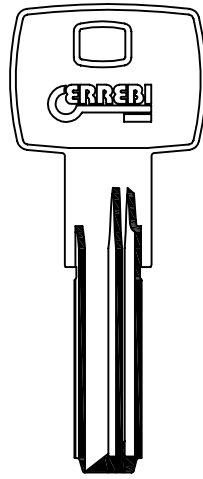

TS18



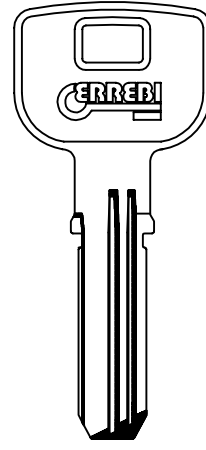

TS19



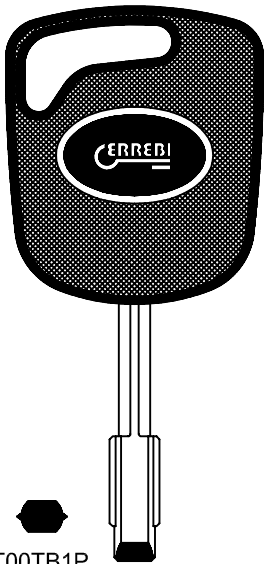

TS20

TS21

FOR: TIBBE®

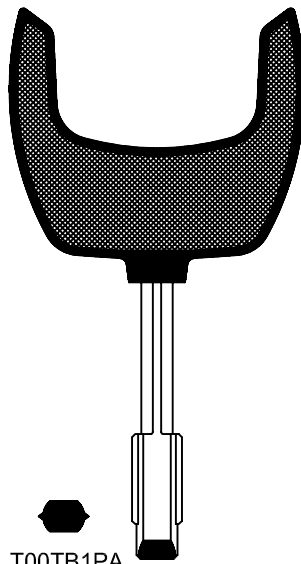

T00TB1P



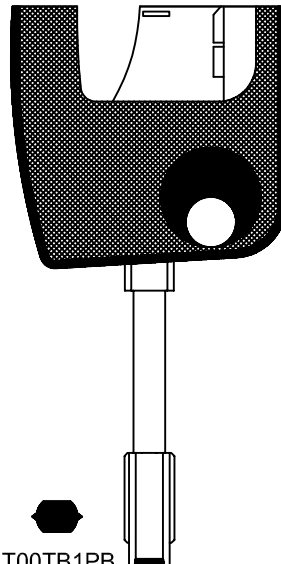

T00TB1PA



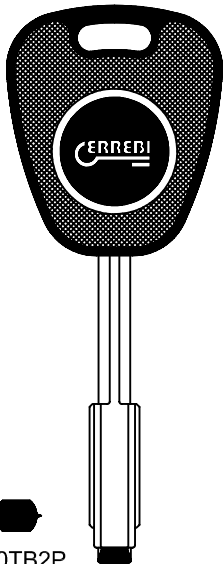

T00TB1PB

FOR: TIBBE®



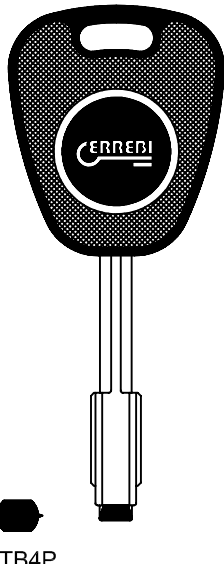

T00TB2P

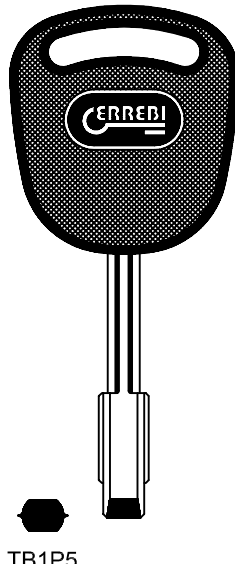

T00TB4P

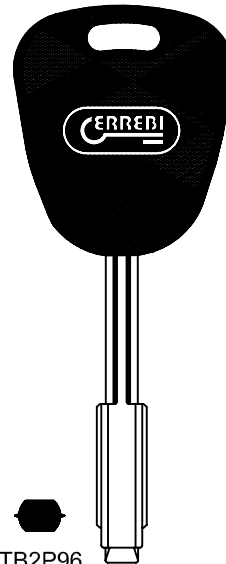

TB1P5





TB2P96

PER / FOR

TESA® (ES)
TIBBE® (DE)

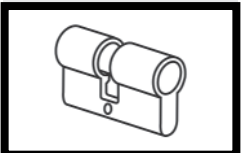

Copyright by
Errebi s.p.a. Unipersonale 2018



PER / FOR

TILANCO® (TW)

TITAN® (SI)

TOK-TRELOCK® (DE)

TOVER® (ES)

FOR: TILANCO®

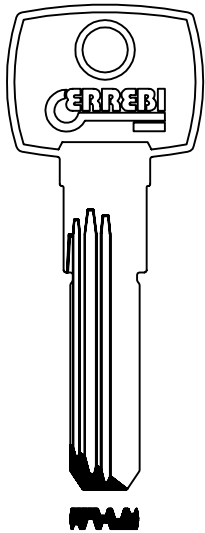

TLC1R

FOR: TITAN®

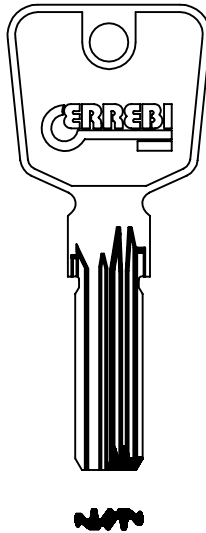

TT13

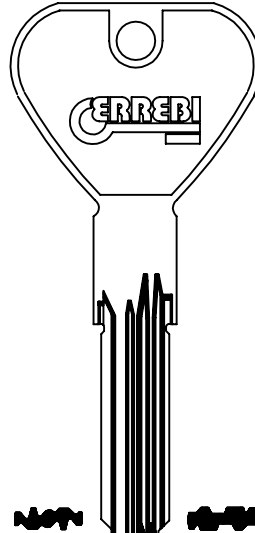

TT20



TT22

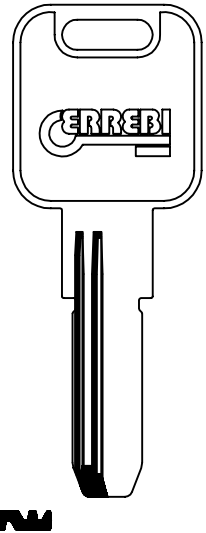

TT25R

FOR: TITAN®

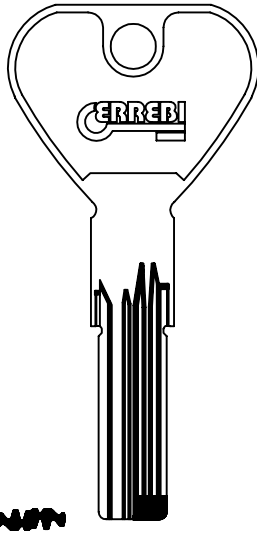

TT26

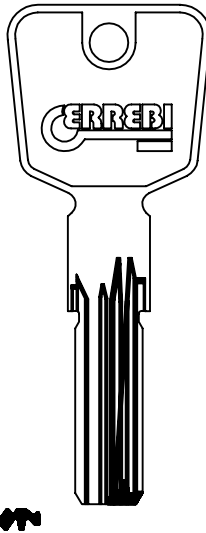

TT27

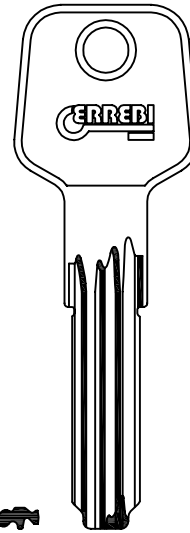

TT28

FOR: TOK-TRELOCK®

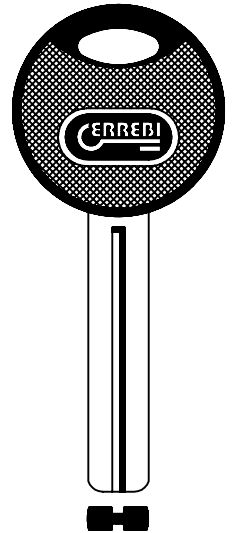

TK41P

FOR: TOVER®

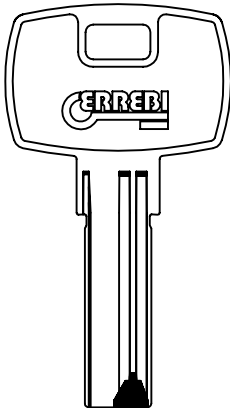

TOV1

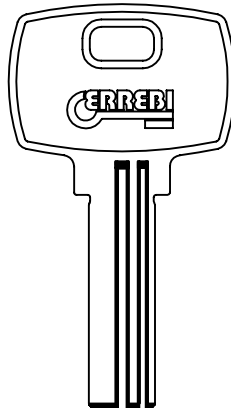

TOV2

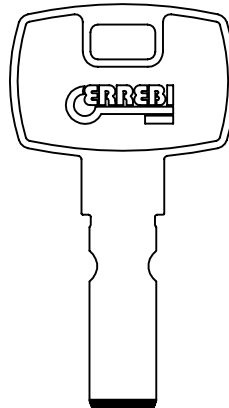

TOV4



TOV8

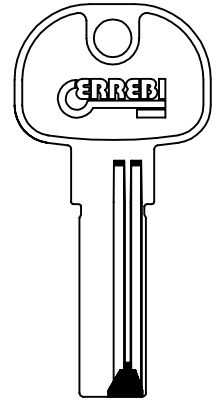

TOV5



Copyright by
Errebi s.p.a. Unipersonale 2018

UNI EN ISO 9001:2008



SISTEMA DI GESTIONE
QUALITÀ CERTIFICATO

CERTIQUALITY
È MEMBRO DELLA
FEDERAZIONE CISO

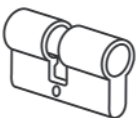

FOR: TOYOTA®

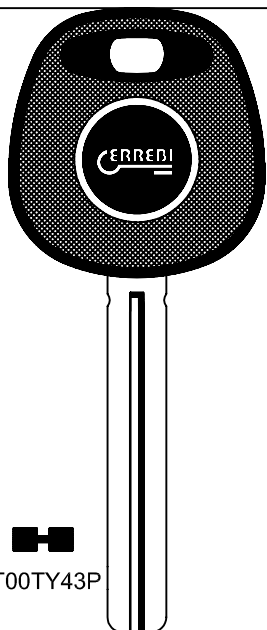

T00TY43P

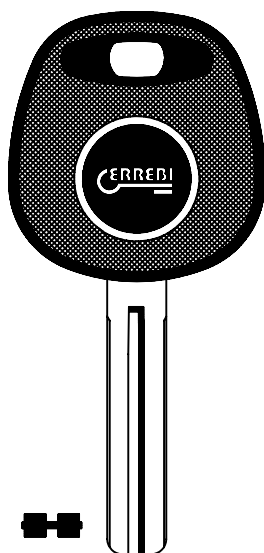

T00TY47P

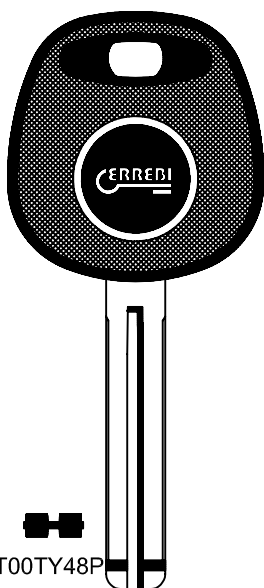

T00TY48P

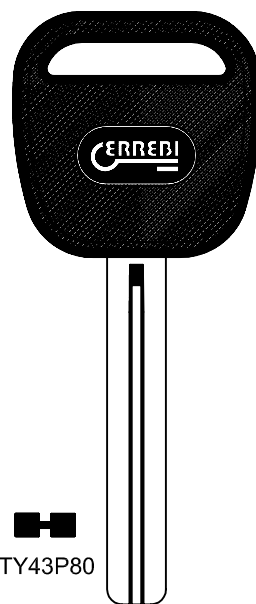

TY43P80

FOR: TOYOTA®

FOR: TRUPER®

FOR: UCER®

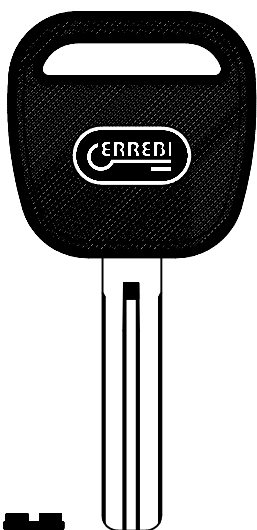

TY47P80

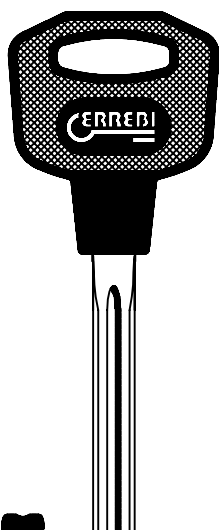

TR1P

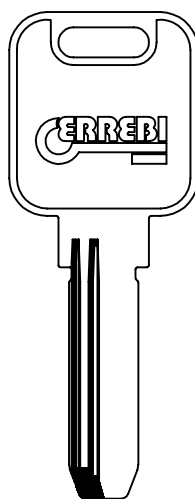

UE7R

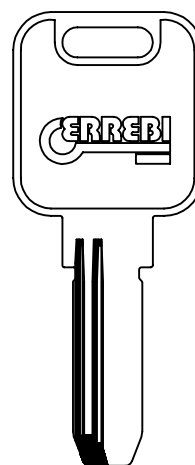

UE8R

FOR: UCER®

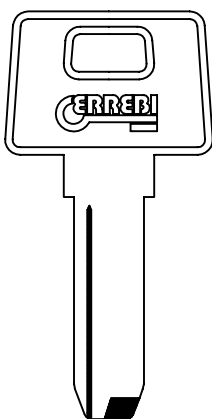

UE9



UE9R

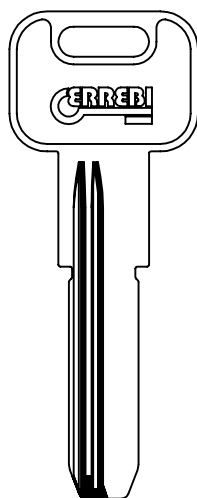

UE12R

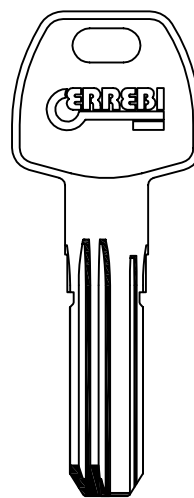

UE14

PER / FOR

TOYOTA® (JP)
TRUPER® (US)
UCER® (ES)



Copyright by
Errebi s.p.a. Unipersonale 2018

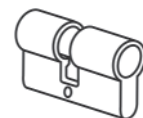

PER / FOR

- URBIS® (RO)
- URKO® (ES)
- VACHETTE® (FR)
- VALEO® (FR)
- VEROFER® (RO)
- VIRO® (IT)
- WALLY® (IT)

FOR: URBIS®

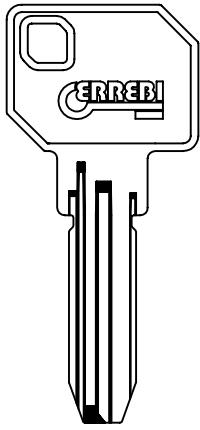

URB1

FOR: URKO®

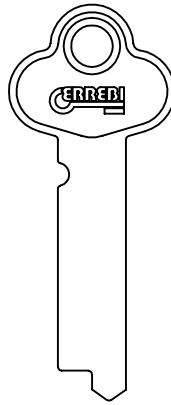

URK1

FOR: VACHETTE®

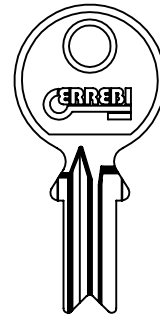

VC15

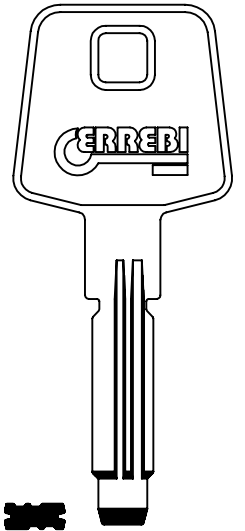

VC80LPP

FOR: VACHETTE®

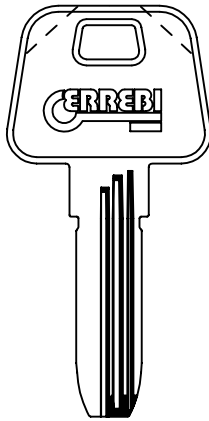

VC87

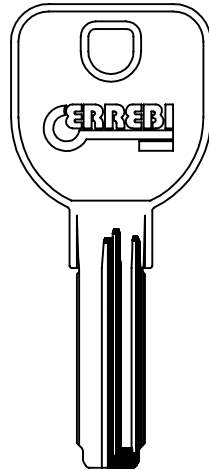

VC89

FOR: VALEO®

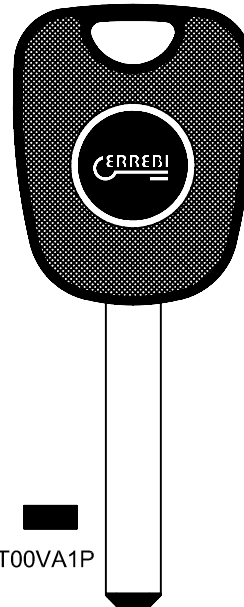

T00VA1P



VA1C1

FOR: VALEO®

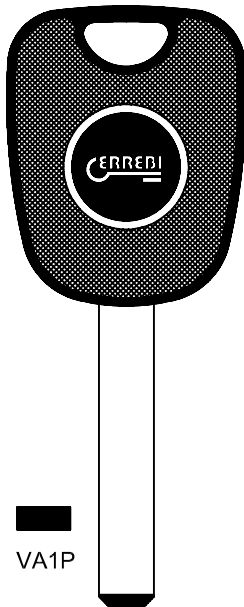

VA1P

FOR: VEROFER®

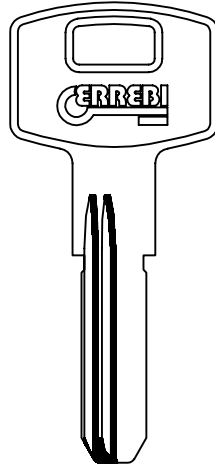

VF1

FOR: VIRO®

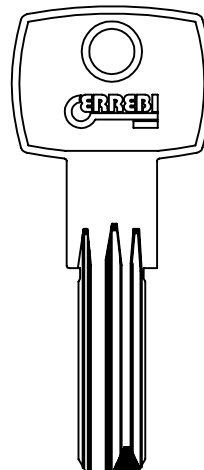

V15

FOR: WALLY®

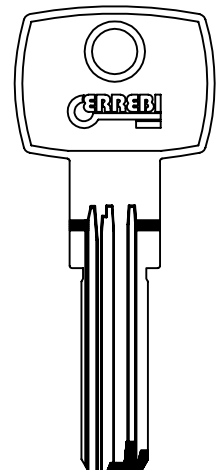

W13



Copyright by
Errebi s.p.a. Unipersonale 2018









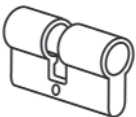

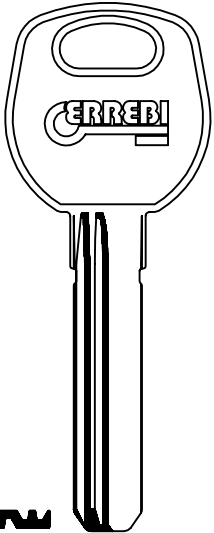
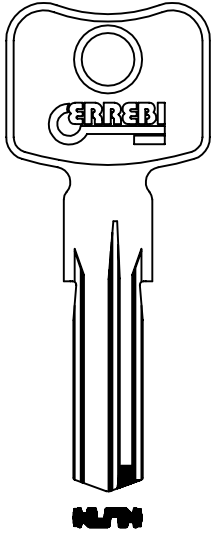
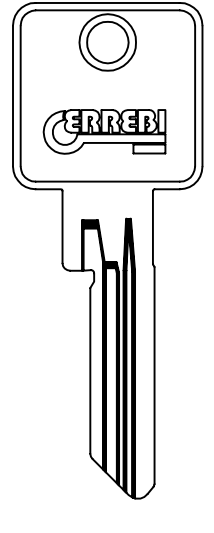
UNI EN ISO 9001:2008

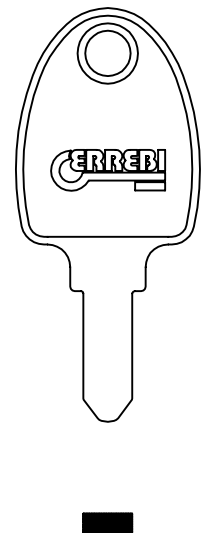
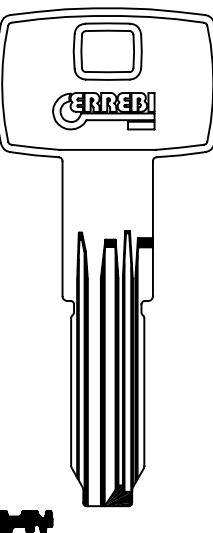
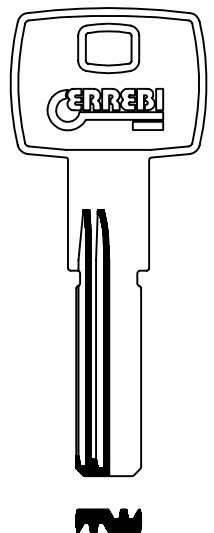
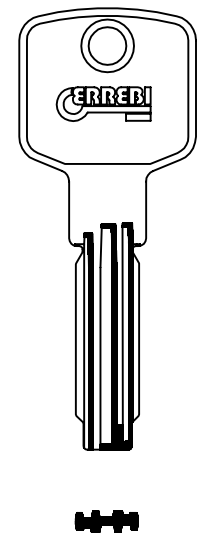
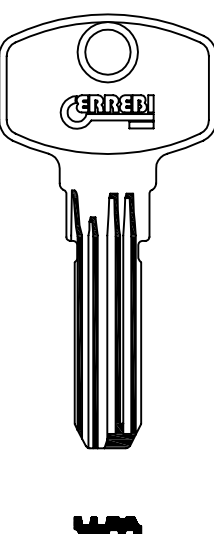
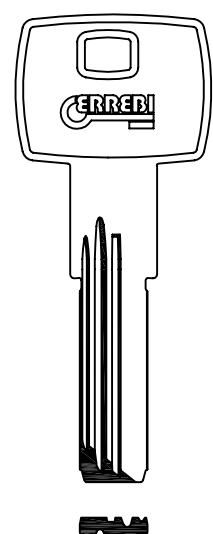
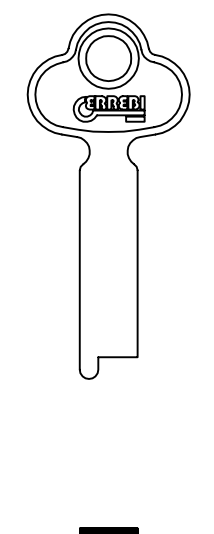
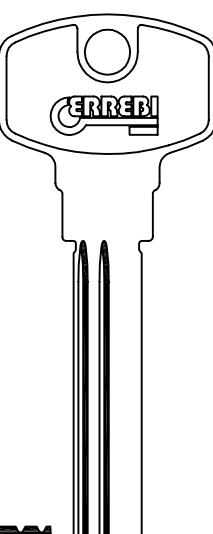

SISTEMA DI GESTIONE
QUALITÀ CERTIFICATO

CERTIQUALITY
È MEMBRO DELLA
FEDERAZIONE CISO

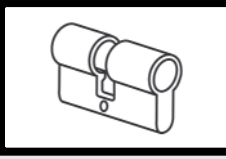

FOR: WANJIN®	FOR: WILKA®	FOR: WINKHAUS®		PER / FOR
 <p>WAN1R</p>	 <p>WI100</p>		 TK23  TK23R  TK25	WANJIN® (CN) WILKA® (DE) WINKHAUS® (DE) WT® (CN) YALE® - I (IT) YALE - CISA® (IT) YALE®-GB (GB)
FOR: WT®	FOR: YALE® I			
 <p>WT1</p>	 <p>YI18</p>	 <p>YI19</p>	 <p>YI20</p>	
FOR: YALE® I		FOR: YALE-CISA®	FOR: YALE® GB	
 <p>YI21</p>	 <p>YI24</p>	 <p>CY</p>	 <p>YG19</p>	 <p>Copyright by Errebi s.p.a. Unipersonale 2018</p>      <p>107</p>

PER / FOR

YARDENI® (IL)
 YETI-PL® (PL)
 YMOS® (DE)

FOR: YARDENI®

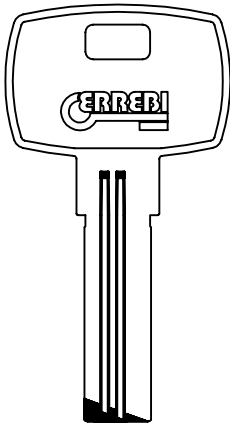



 YR1R

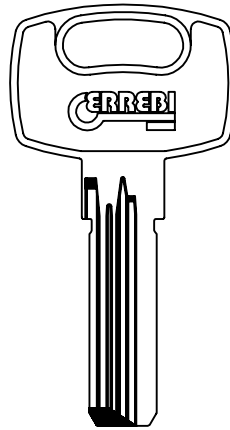

 YR2R



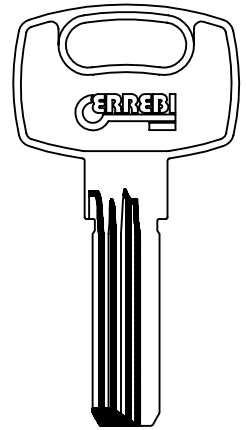

 YR4R

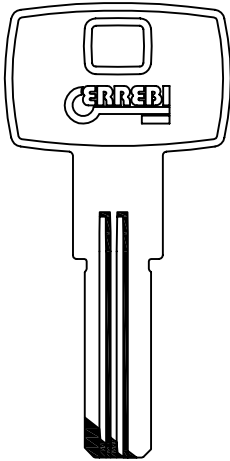

 YR5R

FOR: YETI-PL®



 YE17

FOR: YMOS®





 T00YM22P



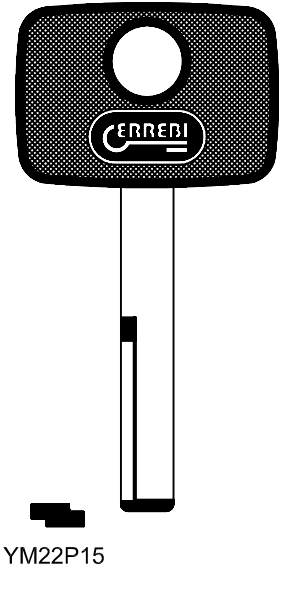

 T00YM30P



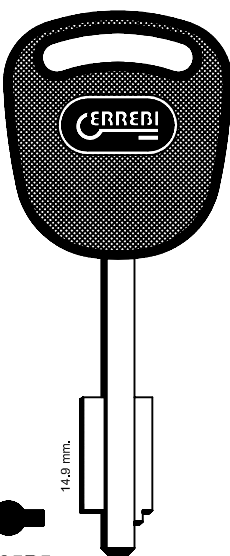

 YM22P15

FOR: YMOS®



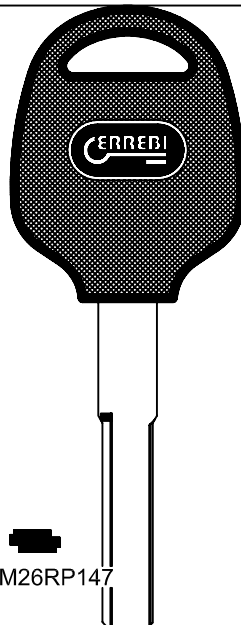

 YM25P5

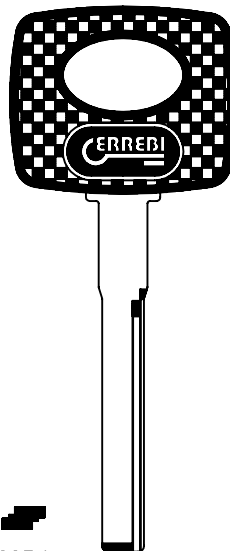

 YM26RP147

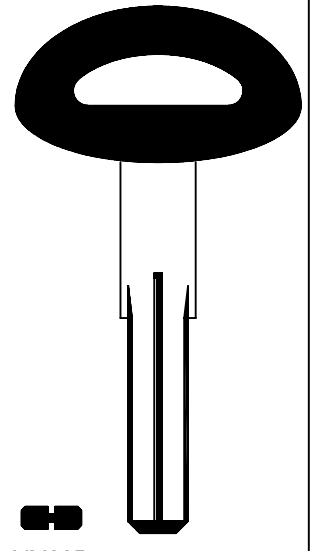

 YM28P17



 YM30P



Copyright by
 Errebi s.p.a. Unipersonale 2018

UNI EN ISO 9001:2008



CERTIQUALITY
 È MEMBRO DELLA
 FEDERAZIONE CISO



SISTEMA DI GESTIONE
 QUALITÀ CERTIFICATO

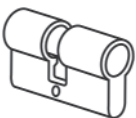

FOR: ZADI®

PER / FOR

ZADI® (IT)

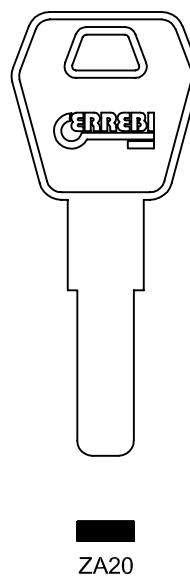
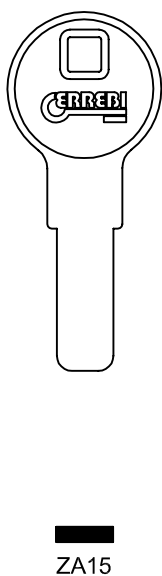
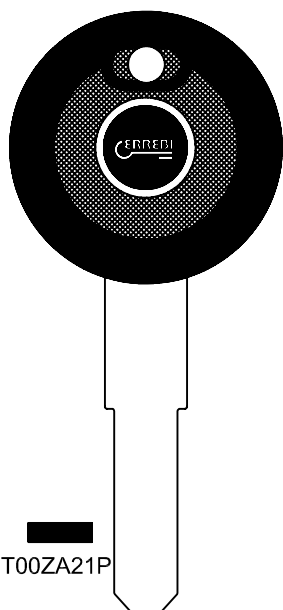

Copyright by
Errebi s.p.a. Unipersonale 2018

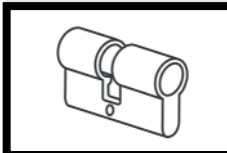

PER / FOR

ORIGINAL KEYS

ABUS

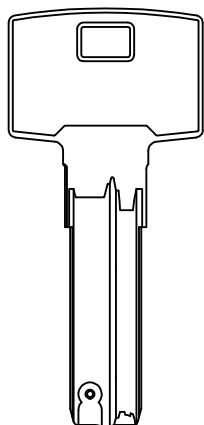

BRAVUS

ABUS-CISA

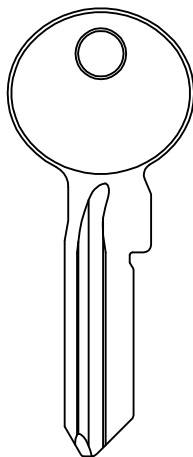

XP/SP

ASSA

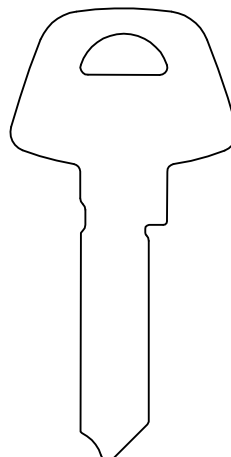

D12

BASI

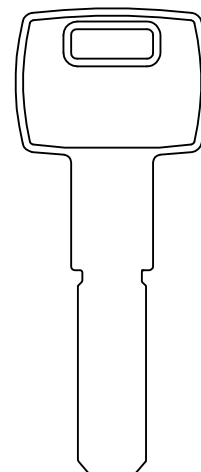

CX6

BKS

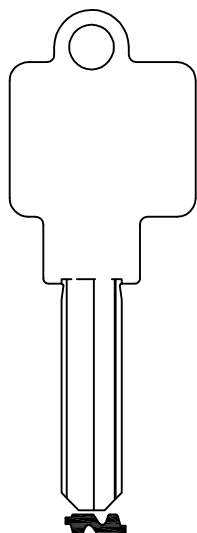

WS 50 NW

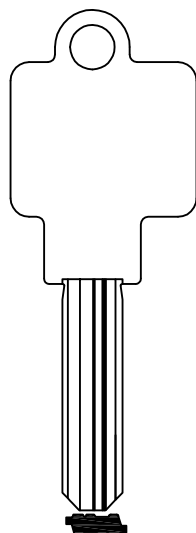

WS 50 RA-RK-RZ

CES

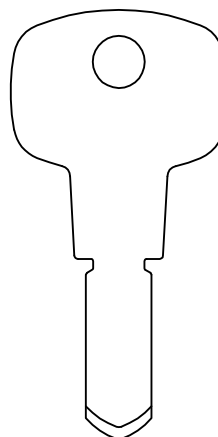

WSM

DOM-DORMA

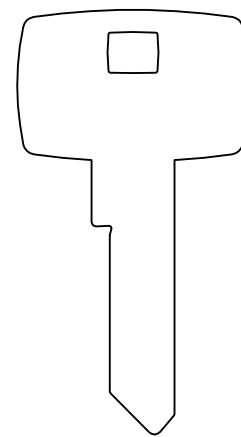

RS8

DOM

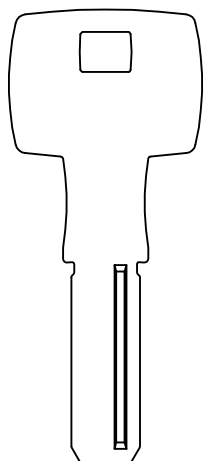

IX DAS 138

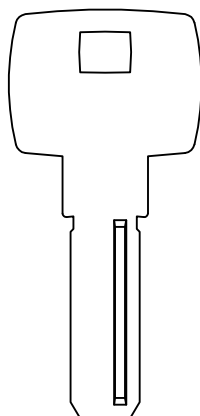

IX5 DAS 038

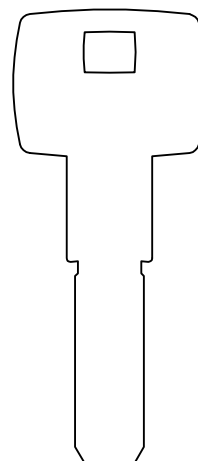

IX6 KG

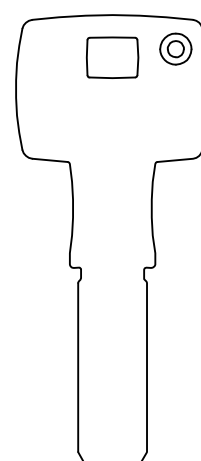







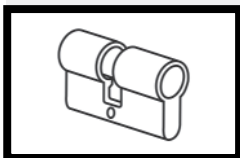

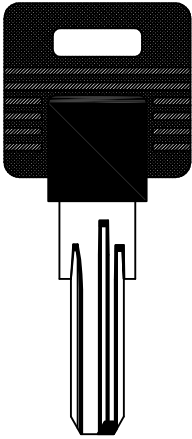
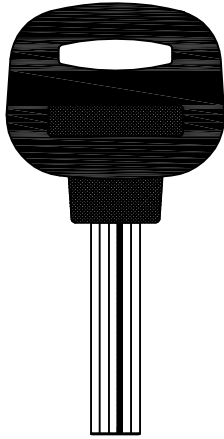
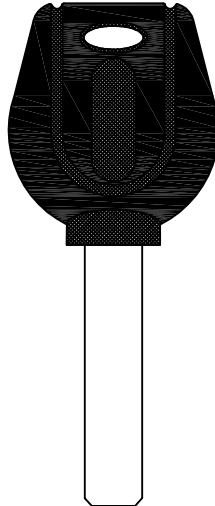
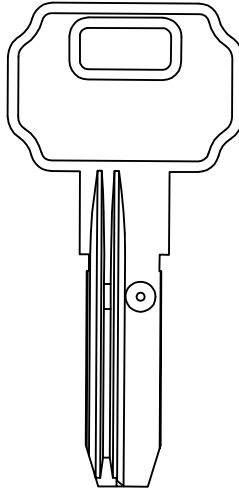

IX6 SR

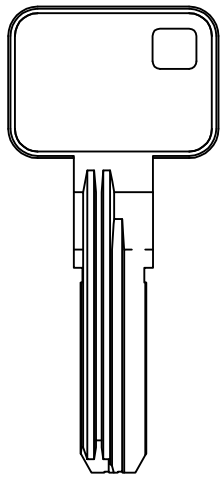
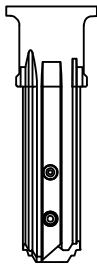
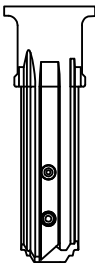
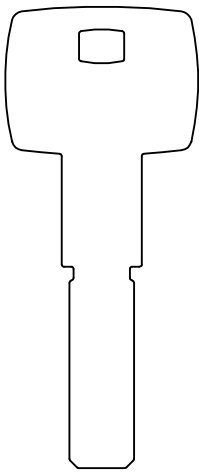

Copyright by Errebi s.p.a. Unipersonale 2018

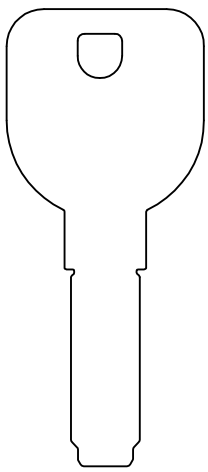
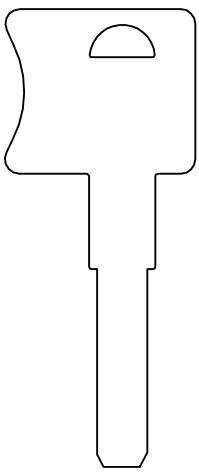

IFAM		LINCE	
			
			
IF1921	IF1922	IF1927	C2 C3 C4
LINCE	MAUER	STS	
			
			
C5	NW4	ST6	ST15
VACHETTE	WINKHAUS		
			
			
VRX	X-TRA		

PER / FOR

ORIGINAL KEYS



Copyright by
Errebi s.p.a. Unipersonale 2018

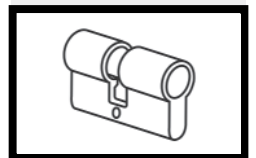

CODE	PAG.	CODE	PAG.	CODE	PAG.	CODE	PAG.	CODE	PAG.
AB1	68	AU106	69	C24L	76	DM37L	78	FXT1	81
AB1P52	68	AU109	69	C24LP	76	DM38L	78	FXT2	81
AB2	68	AUN1R	71	C25L	76	DM39L	78	FY80	80
AB3	68	AX10	72	C25LP	76	DM46	78	GB6P113	82
AB4	68	AX3P167	72	C25T	76	DM60L	78	GB18C1	82
AB5	68	AX3P170	72	C27T	76	DM75L	78	GB18P	82
AB6	68	AX8P170	72	C28L	76	DM75LB	78	GB18P174	82
ACR2	71	AZ7	72	C28LP	76	DM76	78	GDA1P164	82
AGA12	69	AZ7L	72	C33LP	76	DM77	78	GEV1	82
AGA13	69	AZ7R	72	C34L	76	DM82L	78	GU12	83
AGA14	70	AZ8	72	C34LP	76	DM83	78	HBO1	83
AGA15	70	AZ11	72	C40L	76	DM83L	78	HD44P93	83
AGA19T	70	AZ14	72	C40LP	76	DM102	79	HD58P	83
AGA20T	70	AZ16	72	C46LP	76	DM106	79	HF38AP18	84
AGA21	70	AZ17	72	C47LP	76	DM107	79	HF38P17	84
AGA22	70	BAG1	72	C51LP	76	DO6	79	HF39P17	84
AGA23	69	BAG2	73	C52LP	76	DO7	79	HF40P18	84
AGA27	70	BAG3	73	C53	76	DR2	78	HF42C1	84
AGA28	70	BAK1	73	C57LP	76	ECU6	80	HF42P15	84
AGA29	69	BAK2	73	C61	76	ECU7	80	HF48P8	84
AGA30	70	BD12R	74	C62LP	76	ECU8	80	HF49P62	84
AGB10	70	BD22	74	CAY2	75	ECU9	80	HF51P17	84
AGB6	70	BD23L	74	CB7	75	EL11	79	HF52P18	84
AGB7	70	BD25	74	CE42	75	EL16P180	79	HF53P17	84
AGB8	70	BD26	74	CHI9T	75	EL17RP180	79	HF55C1	84
AGB9	70	BD27	74	CHI10T	75	EV24	79	HF55C2	85
AHR2	71	BD28	74	CIS6	75	EZ12	79	HF55C3	85
AHR3	71	BD29	74	CIS8	75	EZ12R	79	HF55C4	85
ALX1	71	BD710	74	CIS9	75	EZ14	79	HF55C5	85
AMG1	71	BD720	74	CO55	76	EZ15	79	HF55P65	85
AMG1R	71	BD730	74	CO58	76	EZ18	79	HF57	85
AMG2	71	BD740	74	CV9	76	FAC19	80	HF59P150	85
AMG3	71	BD750	74	CY	107	FAC23	80	HF63P	85
APE2	71	BD760	74	DF2	77	FAC24	80	HF65C1	85
APE3	71	BEY1	73	DF3	77	FAC25	80	HF65C2	85
APE4	71	BEY2	73	DF4R	77	FAV1R	80	HF65C3	85
APE5	71	BG43	75	DI2	78	FAV2	80	HF65P	85
ASH1	71	BG44	75	DI3	78	FAY2R	80	HF66C1	86
AT12P	71	BG56	75	DIE1	78	FC11	81	HF66C3	86
AU25	68	BIL1T	73	DKB1	77	FC14	81	HF66P	86
AU50	68	BLUX1	73	DKB8	77	FC6	81	HF70P	86
AU51	68	BN11	73	DKB10	77	FF21	80	HF70P171	86
AU54P117	68	BOR1	73	DKB11	77	FM3R	80	HF73C1	86
AU55	68	BOR2	74	DKB12	77	FM4	80	HF74C1	86
AU57L	68	BRA1	74	DLC1	77	FT10	81	HF75C1	86
AU57LP	69	BRS1	75	DLC1R	77	FT20	81	HGO1	89
AU72	69	BRS2	75	DLC2R	77	FT22	81	HOK1	83
AU82	69	BSI2R	73	DLC3	77	FT25	81	HTE1	83
AU84	69	BSI3	73	DLC3R	77	FT26R	82	HYN13P	89
AU91L	69	BSI3R	73	DLC4	77	FT27	82	HYN14C1	89
AU103	69	BUL1	75	DLT1R	78	FT29	81	HYN14P	89
AU105R	69	C21	75	DM27	78	FUA1R	82	I15	90

REF.	PAG.	REF.	PAG.	REF.	PAG.	REF.	PAG.	REF.	PAG.
I16	90	LKS1	94	MR33	96	SCU2	101	T00HF70PBT	88
I20	90	LP610	93	MSM1	97	SE1L	100	T00HF70PT	88
I22	91	LP620	93	MZ22P113	95	SEM7	100	T00HF71P	89
IBF2R	89	LT1	94	NE33P66	98	SEM8	100	T00HF72P	89
IF2	90	LYF2T	94	NE70P70	98	SEM8P	101	T00HF74P	89
IF10P149	90	M19P154	94	NE71P71	98	SEM10P	101	T00HF75P	89
IF12	90	MA6	96	NE81C1	98	SM7P68	101	T00HYN13P	89
IF13	90	MA7	96	NE81P115	98	SM7P74	101	T00HYN13T	89
IF14	90	MA8	96	NOR1	98	SM7P145	101	T00HYN14P	89
INC1T	90	MAS1	94	NOR1R	98	SPR2	101	T00KIA7P	93
INC2T	90	MAS2	95	O7	99	SRT1	101	T00KIA8P181	93
IR1P164	90	MAU4	95	O8	99	STS1N	101	T00KIA8RP181	93
ITO2	91	MD12	95	O11	99	STS1NR	101	T00MHN1P	94
ITO3	91	MD13R	95	OJ22	98	STS5	102	T00NE70P	98
JAG1	91	MD17	95	OJ27	98	STS10	102	T00NE81PA	98
JIS4P	91	MD25	95	P15	100	STS11	102	T00SM7P	101
KAL2	92	MD26	95	P16	100	STS12	102	T00SMR1P	101
KAL3	92	MD27	95	P17	100	STS15	102	T00TB1P	103
KAL4	92	MD30	95	PA6T	99	SUB1P175	102	T00TB1PA	103
KAL7	92	MG10	96	PA6TP	99	T00GB17RPA	82	T00TB1PB	103
KAL11	92	MG11	96	PA7T	99	T00GB17RPB	82	T00TB2P	103
KAL12	92	MG12	96	PF1	81	T00GB18P	83	T00TB4P	103
KAL13	92	MG12R	96	PF1F4L	81	T00GM37P	82	T00TY43P	105
KB1	91	MGN1RP176	94	PF1F6	81	T00HD58P	83	T00TY47P	105
KB2	91	MGN2R	94	PH14R	99	T00HD62P	83	T00TY48P	105
KB2N	91	MH1	96	PH15R	99	T00HD62PA	83	T00VA1P	106
KB3	91	MIL1	96	PH16R	99	T00HF38P	86	T00YM22P	108
KB3N	91	MIL2	96	PH17R	99	T00HF42P	86	T00YM30P	108
KB4	91	MLM5	96	PH18	99	T00HF42PA	86	T00ZA21P	109
KB5	91	MLM6	96	PH19	99	T00HF42PB	86	T7	102
KB6	91	MLT1P76	97	PH19R	99	T00HF48P	87	T8	102
KB7	91	MLT1RDSP76	97	PH21R	99	T00HF49P	87	T8R	102
KC1	92	MLT1RP76	97	PH22R	99	T00HF49PA	87	T10	102
KC2	92	MLT2RP76	97	PH26	99	T00HF51P	87	TB1P5	103
KC2T	92	MLT3P76	97	PH27	99	T00HF55P	87	TB2P96	103
KC3	92	MLT7RP76	97	PH28	99	T00HF55PA	87	TCS1	102
KC4	92	MLT8RP176	97	PH29	99	T00HF55PB	87	TK23	107
KC5	92	MLT9RP176	97	PH29R	99	T00HF55PT1	87	TK23R	107
KC6	93	MLT10RP176	97	PH30R	99	T00HF55PT2	87	TK25	107
KF4	93	MLT11RP169	97	PH31	99	T00HF63P	87	TK41P	104
KIA8P181	93	MLT12RP169	97	PH32	99	T00HF65P	87	TLC1R	104
KIA8RP181	93	MLT13RP169	98	PIC1	100	T00HF65PA	88	TOV1	104
KM1P	93	MLT14R	97	PN1R	100	T00HF65PB	88	TOV2	104
KS50	73	MLT15RP169	98	PN3R	100	T00HF65PC	88	TOV4	104
LA31	93	MLT16RP169	98	PN5R	100	T00HF66P	88	TOV5	104
LA33P65	93	MO3	97	PN7	100	T00HF66PB	88	TOV8	104
LA40	93	MO3P179	97	PNZ2	99	T00HF66PC	88	TR1P	105
LI9R	94	MO4P179	97	PR2	99	T00HF66PD	88	TS12	102
LI16R	94	MR23T	95	RL1	100	T00HF66PE	88	TS14	102
LI17	94	MR24T	95	ROS1	100	T00HF70P	88	TS15	103
LI18R	94	MR26T	95	SCU1	101	T00HF70PA	88	TS18	103

CODE	PAG.
TS19	103
TS20	103
TS21	103
TT13	76
TT13	104
TT20	76
TT20	104
TT22	104
TT25R	104
TT26	104
TT27	76
TT27	104
TT28	104
TY43P80	105
TY47P80	105
UE7R	105
UE8R	105
UE9	105
UE9R	105
UE12R	105
UE14	105
URB1	106
URK1	106
V15	106
VA1C1	106
VA1P	106
VC15	106
VC80LPP	106
VC87	106
VC89	106
VF1	106
VP1	100
W13	106
WAN1R	107
WI100	107
WT1	107
YE17	108
YG19	107
Y18	107
Y19	107
Y120	107
Y121	107
Y124	107
YM22P15	108
YM25P5	108
YM26RP147	108
YM28P17	108
YM30P	108
YR1R	108
YR2R	108
YR4R	108

CODE	PAG.
YR5R	108
ZA15	109
ZA20	109



Errebi s.p.a. Unipersonale

Cibiana (BL) - ITALY

Tel. 0435 542 500

Fax. 0435 542 522

www.errebispa.com

info@errebispa.com

Errebi Deutschland GmbH

Velbert - GERMANY

Tel. (02053) 49 62-0

Fax. (02053) 49 62-22

www.errebi-gmbh.de

info@errebi-gmbh.de

Member of
Altuna Group