

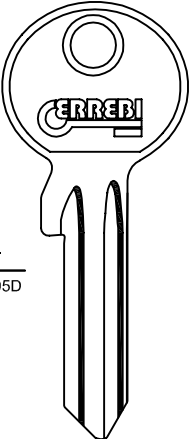

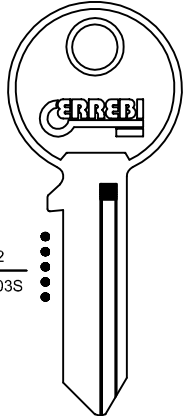

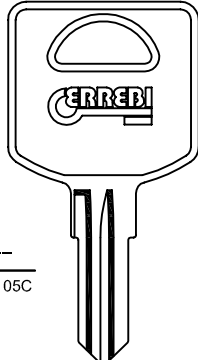





Errebi - news

01 2021

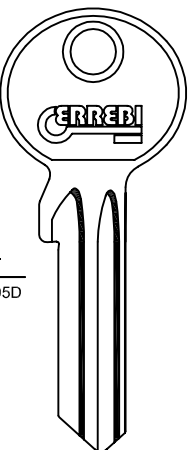
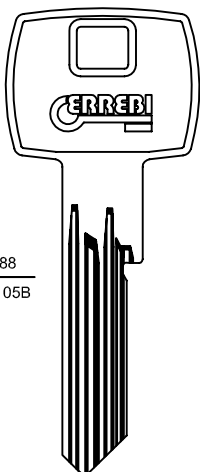
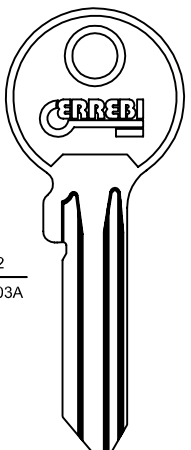
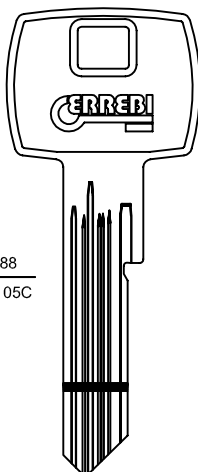
ABUS		ECM		FIC LOCKS	
 <p>S 05D</p>		 <p>12 S 03S</p>		 <p>B 05C</p>	
 AU111  AU112  AU113		 EC5		 FCL1R	
GEGE	IVANA	KALE	NOXXA		
 <p>S 05D</p>	 <p>488 B 05B</p>	 <p>12 S 03A</p>	 <p>488 B 05C</p>		
 GG68	 IVA1	 KAL10RT	 NOX1		

PER/FOR:

ABUS (DE)
ECM (PT)
FIC LOCKS (US)
GEGE (AT)
IVANA (DE)
KALE (TR)
NOXXA (NL)

ERREBI

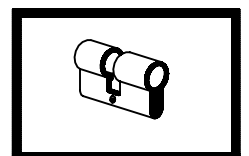









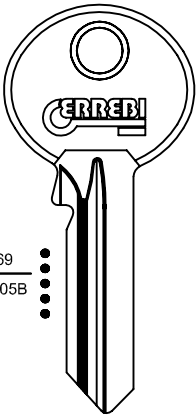

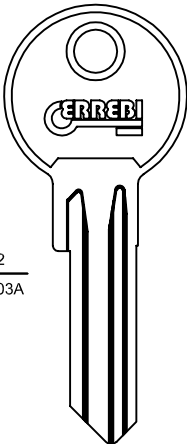

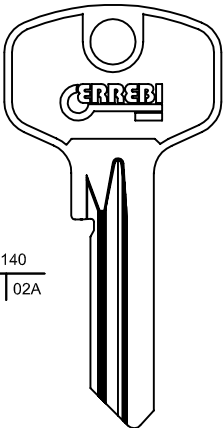

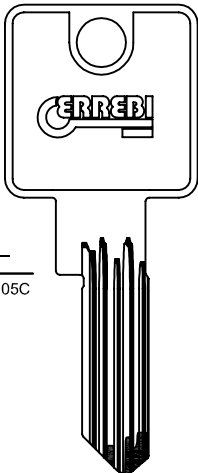

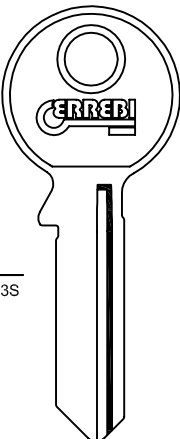
1

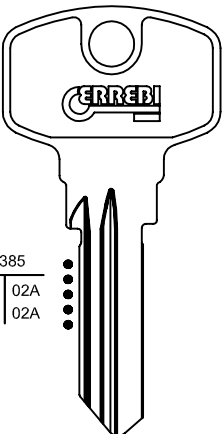
Errebi - news

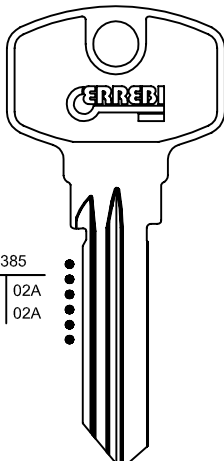
01 2021

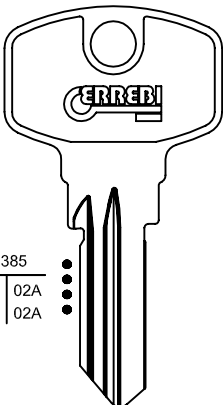
PER/FOR:

RUKO	SATURN	SECUREMME	TOK-WINKHAUS
 <p>269 B 05B</p>  <p>RU47R</p>	 <p>12 S 03A</p>  <p>SAT4R</p>	 <p>140 B 02A</p>  <p>SEM11</p>	 <p>-- S 05C</p> <p>ENAX</p>  <p>TK42</p>
TRI-CIRCLE	YALE (I)		
 <p>-- S 03S</p>  <p>TR26</p>	 <p>385 B 02A S 02A</p>  <p>YI25</p>	 <p>385 B 02A S 02A</p>  <p>YI26</p>	 <p>385 B 02A S 02A</p>  <p>YI27</p>



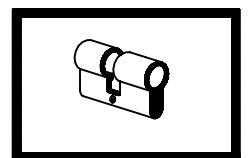

RUKO (DK)
SATURN (SI)
SECUREMME (IT)
TOK-WINKHAUS(DE)
TRI-CIRCLE (SA)
YALE (IT)

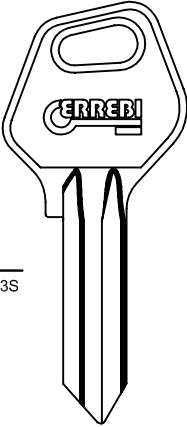

2

Errebi - news

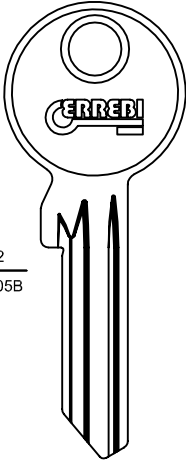
01 2021

WEBSTER	ZEISS-IKON
 <p>-- S 03S</p>  <p>WBS1R</p>	 <p>12 S 05B</p>  <p>ZE500L</p>

PER/FOR:

WEBSTER (GB)
ZEISS-IKON (DE)

ERREBI

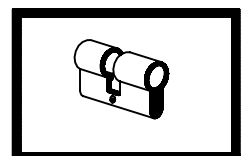

3

Errebi - news

01 2021

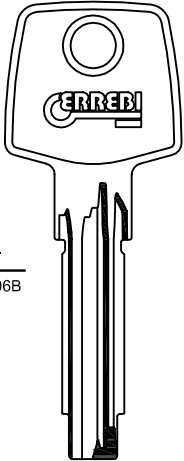
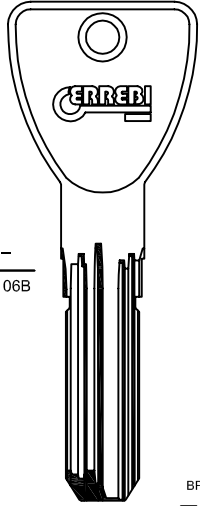
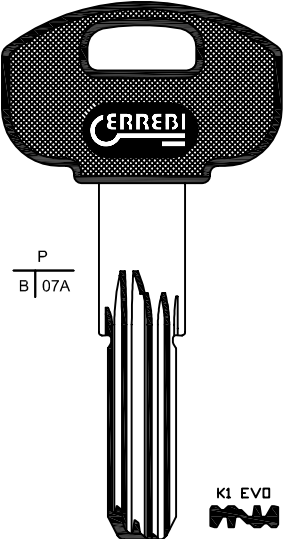
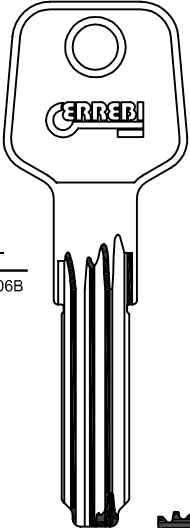
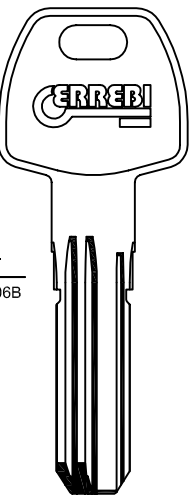
ABUS	MCM	SECUREMME	TITAN
 <p>B 06B</p> <p>EC-S</p> <p>AU109</p>	 <p>B 06B</p> <p>BPS</p> <p>MD30</p>	 <p>P B 07A</p> <p>K1 EVO</p> <p>SEM10P</p>	 <p>B 06B</p> <p>TT28</p>
<p>UCEM</p>  <p>B 06B</p> <p>UE14</p>			

PER/FOR:

ABUS (DE)
MCM (ES)
SECUREMME (IT)
TITAN (SI)
UCEM (ES)

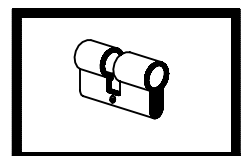









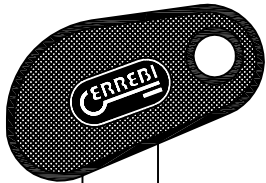

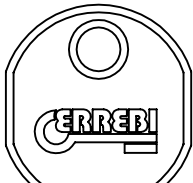
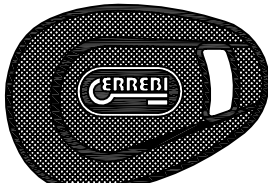

4

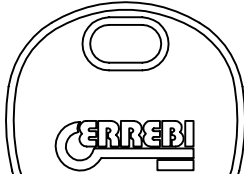
Errebi - news

01 2021

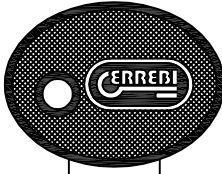
PER/FOR:

ABUS	GIOBERT	GIVI	HONDA
 <p>— S 20A</p>  <p>K1 EVD AU108P</p>	 <p>23A S 17A</p> <p>SECONDARY</p> <p>J... 3001-6732 N... 6001-7000</p> <p>GB11R</p>	 <p>P B 20S</p>  <p>GIV1P GIV2RP</p>	 <p>824 S 17S</p> <p>7-8-9-10</p> <p>HD25R</p>
HONDA	ISUZU	SAFE	SIPEA
 <p>P113 S 20A</p>  <p>HD55RP113</p>	 <p>— B 17A S 17A</p>  <p>ISU8</p>	 <p>P S 20S</p> <p>1 0501-1000</p>  <p>129-1P</p>	 <p>— S 20S</p> <p>H 01-78</p>  <p>SPHP</p>

ABUS (DE)
GIOBERT (IT)
GIVI (IT)
HONDA (JP)
ISUZU (KR)
SAFE (IT)
SIPEA (IT)



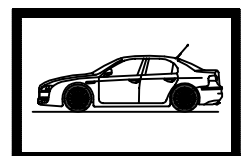

ERREBI

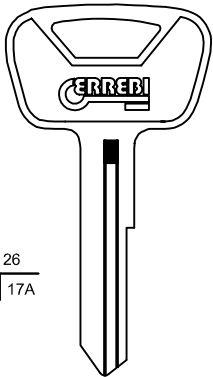
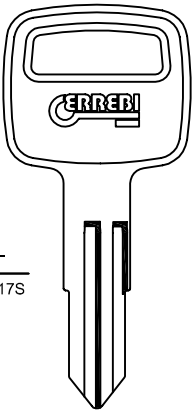

5

Errebi - news

01 2021

TOYOTA	YAMAHA
	
$\frac{126}{S 17A}$	$\frac{-}{S 17S}$
11121-15543 51112-55424	
 6..... TY2	 5..... TY2R
	 YA38
	 YA38R

PER/FOR:

TOYOTA (JP)

YAMAHA (JP)

ERREBI

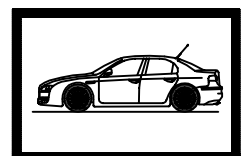

6

Errebi - news

01 2021

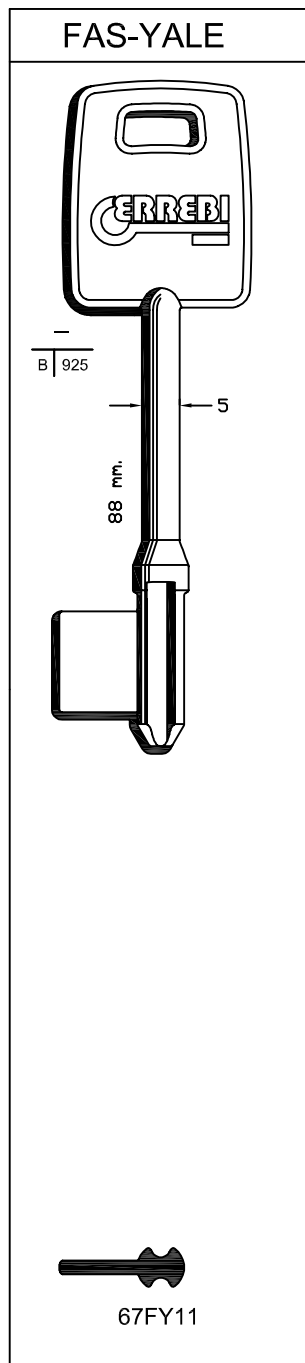

PER/FOR:

FAS-YALE

ERREBI



7

Chiavi sostituite da nuovo modello

PER/FOR:

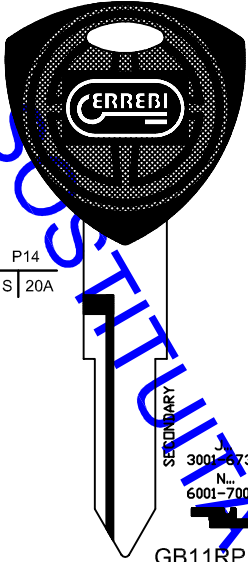
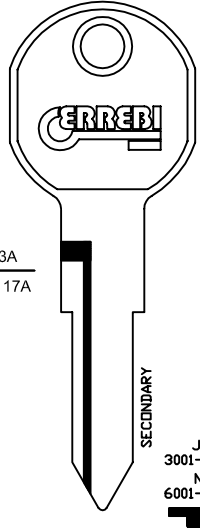
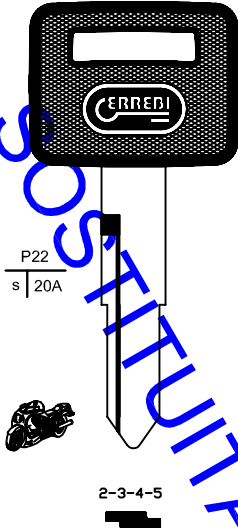
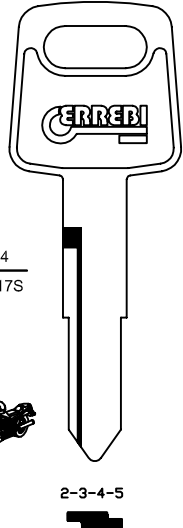
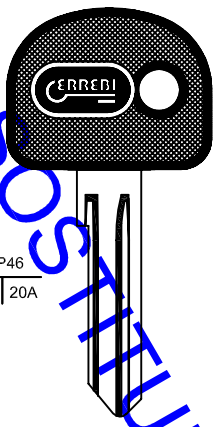
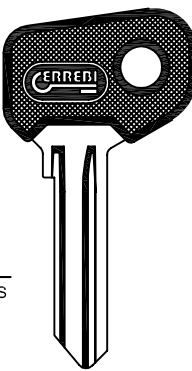
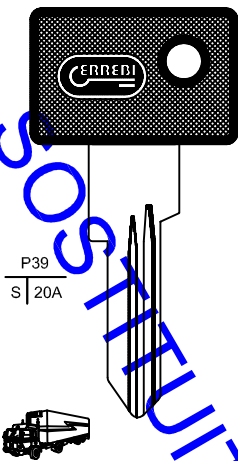
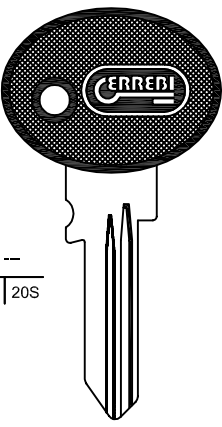
GIOBERT		HONDA	
 <p>P14 S 20A</p> <p>SECONDIARY 3001-6732 N... 6001-7000</p> <p>GB11RP14</p>	 <p>23A S 17A</p> <p>SECONDIARY J... 3001-6732 N... 6001-7000</p> <p>GB11R</p>	 <p>P22 s 20A</p> <p>2-3-4-5</p> <p>HD25RP22</p>	 <p>824 S 17S</p> <p>2-3-4-5</p> <p>HD25R</p>
SAFE		SIPEA	
 <p>P46 S 20A</p> <p>1 0501-1000</p> <p>129-1P46</p>	 <p>P S 20S</p> <p>1 0501-1000</p> <p>129-1P</p>	 <p>P39 S 20A</p> <p>H 01-78</p> <p>SPHP39</p>	 <p>-- S 20S</p> <p>H 01-78</p> <p>SPHP</p>

GIOBERT (IT)
HONDA (JP)
SAFE (IT)
SIPEA (IT)

